

Data sheet | Item number: 2004-911

Fuse plug; with pull-tab; for miniature metric fuses 5 x 20 mm and 5 x 25 mm;
without blown fuse indication; 6.1 mm wide; gray

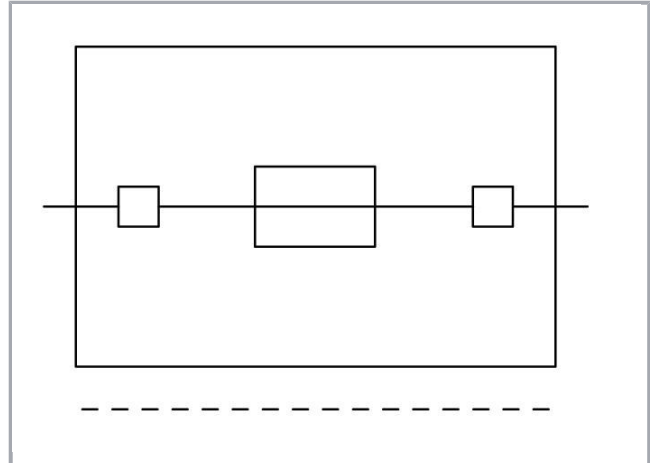

www.wago.com/2004-911

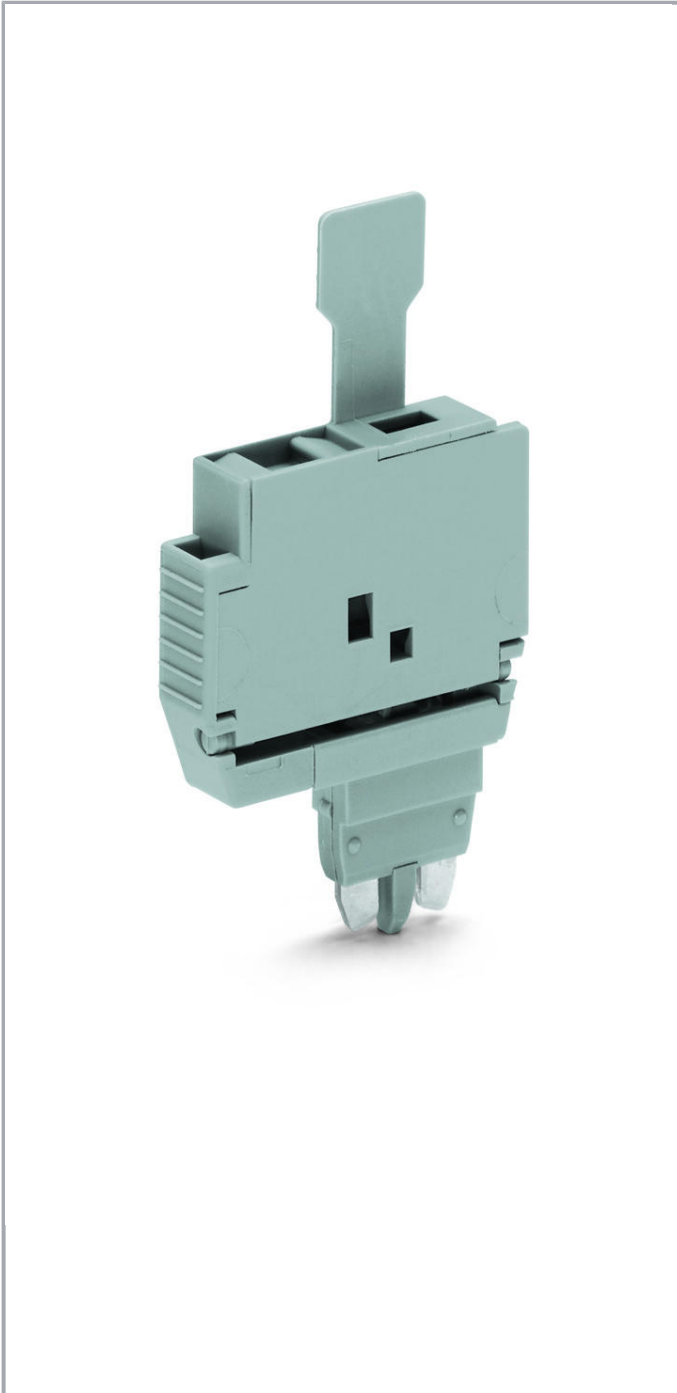

Subject to changes. Please also observe the further product documentation!

WAGO Private Limited
C-27, Sector-58, Phase-III
Noida-201 301 | Gautam Budh Nagar (U.P)
Tel.: +91-120-4369831 | Fax: +91-120-4388799
Email: info.india@wago.com

Do you have any questions about our products?
We are always happy to take your call at +91-120-4388700.

RoHS 
Compliant

[BOMcheck.net](https://www.bomcheck.net)

Color: 

Item description

Safety information 1:

Electrical ratings are given by the fuse.

Data

Electrical data

Ratings per IEC/EN 60664-1

Nominal voltage (III/3)	250 V
Rated current	6.3 A

Geometrical Data

Width	6,1 mm / 0.24 inch
-------	--------------------

Mechanical data

Marking level	Center marking
---------------	----------------

Material Data

Color	gray
Insulation material	Polyamide 66 (PA 66)
Fire load	0.063 MJ
Weight	4 g

Commercial data

Product Group	22 (TOPJOB S)
Packaging type	BOX
Country of origin	CN
GTIN	4055143043991
Customs tariff number	85366990990



Subject to changes. Please also observe the further product documentation!

WAGO Private Limited
C-27, Sector-58, Phase-III
Noida-201 301 | Gautam Budh Nagar (U.P)
Tel.: +91-120-4369831 | Fax: +91-120-4388799
Email: info.india@wago.com

Do you have any questions about our products?
We are always happy to take your call at +91-120-4388700.

Approvals / Certificates

Country specific Approvals

Logo	Approval	Additional Approval Text	Certificate name
	CCA DEKRA Certification B.V.	EN 60947	NTR NL 7730
	CSA DEKRA Certification B.V.	C22.2 No. 158	1536069
	KEMA/KEUR DEKRA Certification B.V.	EN 60947	71- 107687

UL-Approvals

Logo	Approval	Additional Approval Text	Certificate name
	UR Underwriters Laboratories Inc.	UL 1059	E45172

Counterpart

Compatible products

General accessories

Item no.: 281-503

Shorting link; 5 x 20 mm; if the fuse plug is used as disconnect plug

www.wago.com/281-503

Marking accessories

Item no.: 2009-110

Marking strips; on reel; not stretchable; plain; snap-on type; white

www.wago.com/2009-110



Item no.: 2009-115















WMB-Inline; for Smart Printer; 1500 pieces on roll; stretchable 5 - 5.2 mm; plain; snap-on type; white

www.wago.com/2009-115













Subject to changes. Please also observe the further product documentation!

WAGO Private Limited
C-27, Sector-58, Phase-III
Noida-201 301 | Gautam Budh Nagar (U.P)
Tel.: +91-120-4369831 | Fax: +91-120-4388799
Email: info.india@wago.com

Do you have any questions about our products?
We are always happy to take your call at +91-120-4388700.

	<p>Item no.: 2009-115/000-002 WMB-Inline; for Smart Printer; 1500 pieces on roll; stretchable 5 - 5.2 mm; plain; snap-on type; yellow</p>	<p>www.wago.com/2009-115/000-002</p>
	<p>Item no.: 2009-115/000-006 WMB-Inline; for Smart Printer; 1500 pieces on roll; stretchable 5 - 5.2 mm; plain; snap-on type; blue</p>	<p>www.wago.com/2009-115/000-006</p>
	<p>Item no.: 2009-115/000-007 WMB-Inline; for Smart Printer; 1500 pieces on roll; stretchable 5 - 5.2 mm; plain; snap-on type; gray</p>	<p>www.wago.com/2009-115/000-007</p>
	<p>Item no.: 2009-115/000-012 WMB-Inline; for Smart Printer; 1500 pieces on roll; stretchable 5 - 5.2 mm; plain; snap-on type; orange</p>	<p>www.wago.com/2009-115/000-012</p>
	<p>Item no.: 2009-115/000-017 WMB-Inline; for Smart Printer; 1500 pieces on roll; stretchable 5 - 5.2 mm; plain; snap-on type; light green</p>	<p>www.wago.com/2009-115/000-017</p>
	<p>Item no.: 2009-115/000-023 WMB-Inline; for Smart Printer; 1500 pieces on roll; stretchable 5 - 5.2 mm; plain; snap-on type; green</p>	<p>www.wago.com/2009-115/000-023</p>
	<p>Item no.: 2009-115/000-024 WMB-Inline; for Smart Printer; 1500 pieces on roll; stretchable 5 - 5.2 mm; plain; snap-on type; violet</p>	<p>www.wago.com/2009-115/000-024</p>
	<p>Item no.: 793-501 WMB marking card; as card; not stretchable; plain; snap-on type; white</p>	<p>www.wago.com/793-501</p>
	<p>Item no.: 793-501/000-002 WMB marking card; as card; not stretchable; plain; snap-on type; yellow</p>	<p>www.wago.com/793-501/000-002</p>
	<p>Item no.: 793-501/000-005 WMB marking card; as card; not stretchable; plain; snap-on type; red</p>	<p>www.wago.com/793-501/000-005</p>
	<p>Item no.: 793-501/000-006 WMB marking card; as card; not stretchable; plain; snap-on type; blue</p>	<p>www.wago.com/793-501/000-006</p>
	<p>Item no.: 793-501/000-007 WMB marking card; as card; not stretchable; plain; snap-on type; gray</p>	<p>www.wago.com/793-501/000-007</p>
	<p>Item no.: 793-501/000-012 WMB marking card; as card; not stretchable; plain; snap-on type; orange</p>	<p>www.wago.com/793-501/000-012</p>
	<p>Item no.: 793-501/000-017 WMB marking card; as card; not stretchable; plain; snap-on type; light green</p>	<p>www.wago.com/793-501/000-017</p>

Subject to changes. Please also observe the further product documentation!

	Item no.: 793-501/000-023 WMB marking card; as card; not stretchable; plain; snap-on type; green	www.wago.com/793-501/000-023
	Item no.: 793-501/000-024 WMB marking card; as card; not stretchable; plain; snap-on type; violet	www.wago.com/793-501/000-024
	Item no.: 793-5501 WMB marking card; as card; for terminal block width 5 - 17.5 mm; stretchable 5 - 5.2 mm; plain; snap-on type; white	www.wago.com/793-5501
	Item no.: 793-5501/000-002 WMB marking card; as card; for terminal block width 5 - 17.5 mm; stretchable 5 - 5.2 mm; plain; snap-on type; yellow	www.wago.com/793-5501/000-002
	Item no.: 793-5501/000-005 WMB marking card; as card; for terminal block width 5 - 17.5 mm; stretchable 5 - 5.2 mm; plain; snap-on type; red	www.wago.com/793-5501/000-005
	Item no.: 793-5501/000-006 WMB marking card; as card; for terminal block width 5 - 17.5 mm; stretchable 5 - 5.2 mm; plain; snap-on type; blue	www.wago.com/793-5501/000-006
	Item no.: 793-5501/000-007 WMB marking card; as card; for terminal block width 5 - 17.5 mm; stretchable 5 - 5.2 mm; plain; snap-on type; gray	www.wago.com/793-5501/000-007
	Item no.: 793-5501/000-012 WMB marking card; as card; for terminal block width 5 - 17.5 mm; stretchable 5 - 5.2 mm; plain; snap-on type; orange	www.wago.com/793-5501/000-012
	Item no.: 793-5501/000-017 WMB marking card; as card; for terminal block width 5 - 17.5 mm; stretchable 5 - 5.2 mm; plain; snap-on type; green	www.wago.com/793-5501/000-017
	Item no.: 793-5501/000-023 WMB marking card; as card; for terminal block width 5 - 17.5 mm; stretchable 5 - 5.2 mm; plain; snap-on type; light green	www.wago.com/793-5501/000-023
	Item no.: 793-5501/000-024 WMB marking card; as card; for terminal block width 5 - 17.5 mm; stretchable 5 - 5.2 mm; plain; snap-on type; violet	www.wago.com/793-5501/000-024
clamps		
	Item no.: 2002-1661 2-conductor carrier terminal block; for DIN-rail 35 x 15 and 35 x 7.5; 2.5 mm ² ; Push-in CAGE CLAMP®; 2,50 mm ² ; gray	www.wago.com/2002-1661
	Item no.: 2002-1761 3-conductor carrier terminal block; for DIN-rail 35 x 15 and 35 x 7.5; 2.5 mm ² ; Push-in CAGE CLAMP®; 2,50 mm ² ; gray	www.wago.com/2002-1761
	Item no.: 2002-1861	

Subject to changes. Please also observe the further product documentation!



4-conductor carrier terminal block; for DIN-rail 35 x 15 and 35 x 7.5; 2.5 mm²; Push-in CAGE CLAMP®; 2,50 mm²; gray www.wago.com/2002-1861



Item no.: 2002-1961

2-conductor carrier terminal block; with additional jumper position; for DIN-rail 35 x 15 and 35 x 7.5; 2.5 mm²; Push-in CAGE CLAMP®; 2,50 mm²; gray www.wago.com/2002-1961



Item no.: 2002-2961

Double-deck carrier terminal block; L/L; for DIN-rail 35 x 15 and 35 x 7.5; 2.5 mm²; Push-in CAGE CLAMP®; 2,50 mm²; gray www.wago.com/2002-2961



Item no.: 2002-2963

Double-deck carrier terminal block; L/N; for DIN-rail 35 x 15 and 35 x 7.5; 2.5 mm²; Push-in CAGE CLAMP®; 2,50 mm²; gray www.wago.com/2002-2963

Downloads

Documentation

Additional Information

Technical explanations	Apr 3, 2019	pdf 2.1 MB	Download
------------------------	-------------	---------------	----------

CAD/CAE-Data

CAD data

2D/3D Models 2004-911	URL	Download
-----------------------	-----	----------

CAE data

WSCAD Universe 2004-911	URL	Download
-------------------------	-----	----------

Handling Instructions

Subject to changes. Please also observe the further product documentation!

WAGO Private Limited
 C-27, Sector-58, Phase-III
 Noida-201 301 | Gautam Budh Nagar (U.P)
 Tel.: +91-120-4369831 | Fax: +91-120-4388799
 Email: info.india@wago.com

Do you have any questions about our products?
 We are always happy to take your call at +91-120-4388700.

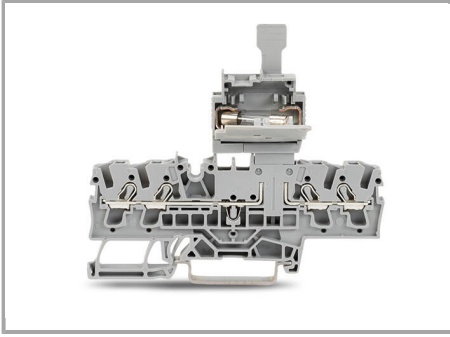

Using fuse plugs with rail-mount terminal blocks for control circuit protection is highly advantageous because the function and wiring levels are separated:

- No additional cost for assembly and wiring
-
- No risk of accidental contact with live parts when disconnecting the fuse plug
-
- The fuse plug is completely separated from the carrier terminal block when replacing a fuse – away from current carrying parts
-
- The fuse plug can be removed by service personnel
-
- No unintentional reclosing of the circuit by another person
-
- Quickly exchange a fuse by using a prepared “stand-by plug”
-

Fuse plug features for quick and safe applications:

Subject to changes. Please also observe the further product documentation!



- Optional LED indicates blown fuse
-
- Top-of-unit marking slot provides clear carrier terminal block identification
-
- Two test slots with touch contacts
-
- Terminal blocks/plugs provide high-density wiring in a width of just 6.1 mm
-
- May be used as a disconnect plug in combination with a shorting link
-

Subject to changes. Please also observe the further product documentation!

WAGO Private Limited
C-27, Sector-58, Phase-III
Noida-201 301 | Gautam Budh Nagar (U.P)
Tel.: +91-120-4369831 | Fax: +91-120-4388799
Email: info.india@wago.com

Do you have any questions about our products?
We are always happy to take your call at +91-120-4388700.

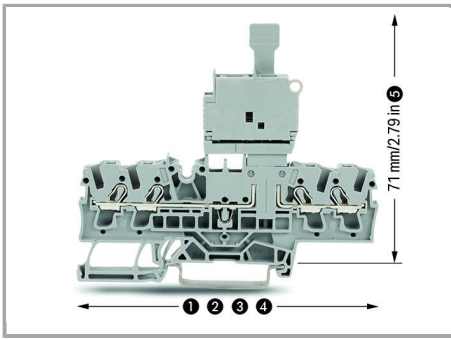

Fuse plug dimensions:

66.1 mm / 2.62 inch for 2002-1661

76.8 mm / 3.02 inch for 2002-1761

87.5 mm / 3.45 inch for 2002-1861

72.9 mm / 2.87 inch for 2002-1961

with inserted fuse plug

Subject to changes. Please also observe the further product documentation!

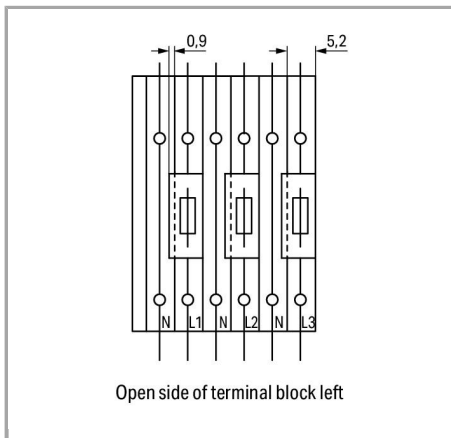

Please note:

The extra width of the plug (6.1 mm compared to 5.2 mm for carrier terminal blocks) must be compensated for with intermediate plates (1 mm) when building an assembly of carrier terminal blocks equipped with fuse plugs.

Subject to changes. Please also observe the further product documentation!



Glass cartridge fuses 5 x 20				
Series Item No.	Overload and short circuit protection		Short circuit protection only	
	Individual argmt.	Group argmt.	Individual argmt.	Group argmt.
Fuse terminal blocks				
2004-911				
2004-911/...-....	1.6 W	1.6 W	2.5 W	2.5 W

When selecting miniature metric fuses, make sure that the maximum power loss listed above is not exceeded. The power loss is determined according to IEC or EN 60947-7-3/VDE 0611-6 at 23 °C. The temperature rise of the terminal blocks must be checked according to their application and mounting. Higher ambient temperatures place additional strain on fuse cartridges. Therefore, in such applications, the rated current must be reduced if necessary. More details are available from the fuse manufacturers.

Product family

TOPJOB® S

TOPJOB® S: In various industrial applications and modern building installations, WAGO's wide and versatile range of rail-mount terminal blocks provides more than just reliable electrical connections.

[Show all products from the family](#)

Subject to changes. Please also observe the further product documentation!