

# Specialised medical electrical equipment and accessories



First established in 1920, Clipsal is Australia's number one manufacturer of electrical products, accessories and solutions. Over the years Clipsal have grown and evolved with great success, and continued to manufacture product at multiple facilities across Australia. As an industry leader, Clipsal is dedicated to supplying customers with the most innovative and sustainable electrical solutions available on the market. Clipsal, as part of Schneider Electric, the largest global specialists in energy management, enables us to provide a total electrical solution for any project or application.

### Health Solutions

Clipsal Health Solutions focuses on improving the efficiency and reliability of electrical systems within health care facilities. This is done by incorporating technology that benefits medical staff, patients and facility management departments. A perfect example is the integration of the following critical services: fast-response IP nurse call, lighting control, building management, HVAC and security systems. Patients are protected by advanced electrical safety devices and sockets, plus increased infection control properties.

These systems are designed for ease of operation by staff and patients through high level integration. They will not only improve safety and comfort, but also greatly increase energy efficiency. Further energy savings can be achieved through energy efficient lighting and plant motor control, which deliver a positive return on investment and reduce maintenance costs through efficient use of energy and power.

#### **Clipsal Health Solutions assist to:**

- provide fast-response integrated nurse call
- enhance the care, safety and comfort of staff and patients
- provide advanced electrical safety devices and sockets
- integrate lighting control, building management, HVAC, security and monitoring
- reduce operating costs and provide a positive return on infrastructure investment
- implement high-speed, scalable, future-proof data networks and technology that benefits staff productivity
- ensure constant and continual delivery of critical power
- provide robust, flexible and customised medical service panel solutions
- reduce the spread of infection through use of advanced technologies
- provide an intelligent energy management solution with EcoStruxure™, to reduce energy costs and improve operating efficiency.

## Medilec – Specialists in Medical Electrical Equipment and Accessories

Medilec provides a wide range of electrical equipment for patient treatment areas of hospitals, medical and dental practices.

The Medilec range of medical electrical accessories and electrical safety equipment are specifically developed to suit the specialised requirements of the medical industry.

This includes the design, development and manufacturing of residual current devices (RCDs), line isolation and overload monitors (LIOMs), medical service panels, isolation transformers, equipotential junctions and RCD protected power outlets.

Medilec products have become a key component in many landmark hospitals across Australia. These include:

- The Prince Charles Hospital, Queensland
- Joondalup Public Hospital, Western Australia
- Launceston General Hospital, Tasmania
- Warrnambool Hospital, Victoria
- Royal Children's Hospital, Melbourne
- Royal Adelaide Hospital
- Mater Mothers' Hospitals, Brisbane.

## Product Range

---

The Medilec range is designed to incorporate the Medilec ML2000 and Clipsal 2000 Series range of electrical accessories, as well as the various OEM products based on the Clipsal 2000 Series format.

The Medilec range complies with the relevant Australian Standards, as well as standards for patient treatment areas, including AS/NZS 3003, "Electrical installations – patient treatment areas of hospitals, medical and dental practices", and AS/NZS 3190, "Approval and test specifications for residual current devices".

AS/NZS 3003 sets out the specialist electrical installation requirements often found in the following premises:

- Hospitals
- Day surgery facilities
- Medical practices
- Dental practices
- Physiotherapy practices

### ML2000

#### **Economical moulded solution**

When you are looking for a economical and homely solution.



### ML2165

#### **Plaster mounted recessed solution**

When you require a modular solution that's quick and easy to install. Suitable for a new or retrofit installation.

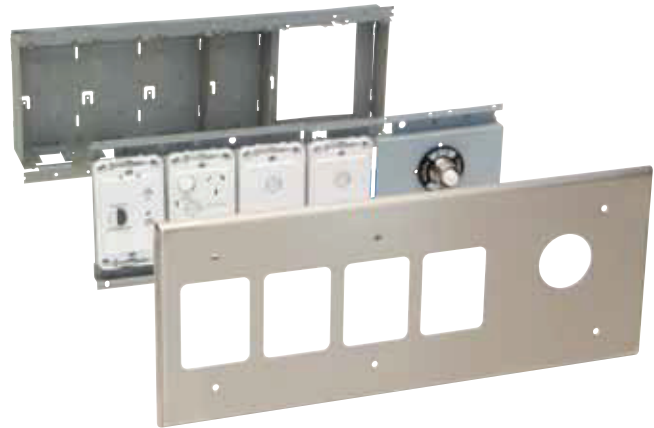

## ML2164

### Stud mounted flush solution

When you require a proven performer that is fully recessed and modular.



## ML2144

### Custom timber solution

When you require a custom modular solution to mount into bed furniture or timber railing.



## MLH921

### Surfaced mounted duct solution

When you require a fast modular solution suitable for a new or retrofit installation.



## ESP

### Premium electronic safety products

When you require trusted premium protection in critical care areas.

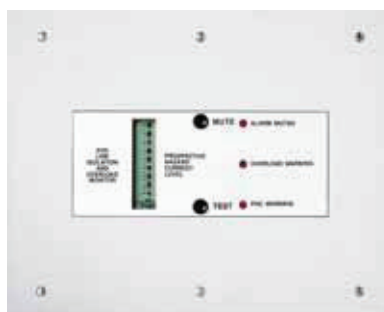

# Contents

- **Page 08**

---

**ML2000**  
**Economical moulded solution**  
RCDs, Alarms, Socket outlets, Equipotential Earth Studs, Accessories
  
- **Page 22**

---

**ML2165**  
**Plaster mounted recessed solution**  
Service Panel, LV, ELV & Gas Modules,  
Equipotential Junction, Accessories
  
- **Page 28**

---

**ML2164**  
**Stud mounted flush solution**  
Service Panel, Wall Boxes, Grids, Facias,  
Equipotential Junction, Accessories
  
- **Page 36**

---

**MLH921**  
**Surfaced mounted duct solution**  
Duct, LV, ELV & Gas Modules, Equipotential Junction, Accessories
  
- **Page 44**

---

**ML2144**  
**Custom timber solution**  
Service Panel, Grids, Facias, Equipotential Junction, Accessories
  
- **Page 50**

---

**ESP**  
**Premium electronic safety products**  
Wall Boxes, RCDs/MCBs, LIOMS, Alarms, Socket Outlets,  
Transformers, Equipotential Junction, Accessories
  
- **Page 70**

---

**Index**





### Economical moulded solution

Part of the Medilec range is the ML2000 Series of moulded hospital electrical accessories. The ML2000 Series products are based on the famous Clipsal 2000 Series system, but they have been specially developed with additional features to suit the specialised requirements for hospital patient treatment areas.

The ML2000 Series products, combined with the extensive range of Clipsal 2000 Series electrical accessories (OEM 2000 Series Nurse Call Points and Gas Outlets, and Clipsal 1–4 gang 2000 Series surrounds and mounting boxes/brackets), produce a very economical and modular medical service panel system that not only is quick and easy to produce, but also looks attractive and provides a homely feel to the environment.



**ML2000 Series medical service panel (example only)**

## Features and benefits

- Wall or stud-mounted (recommended for use with wall-mounting boxes or stud brackets)
- Designed to accommodate specialist equipment required for hospital treatment areas
- Surround dimensions suitable for all Clipsal 2000 Series electrical accessories
- Can easily accommodate multiple medical units in one surround (available in clusters of 2-4 gangs per surround)
- Ease of installation (pre and post-wall construction)
- Available pre-wired and assembled or individual accessories can be ordered as required

### Residual Current Devices (RCDs)

The ML2031RC range of RCDs are based on the Clipsal 2031RC range of RCDs, which provide protection against electrocution.

#### Features

- 10mA trip current.
- Amber indicator marked "SUPPLY POWER AVAILABLE".
- Red indicator marked "LINE POWER AVAILABLE".
- In-built test facility.
- Uses the flexible Clipsal 2000 Series system.



ML2031VRC10



ML2031RC10

Catalogue No.	Description
ML2031VRC10	RCD, Single gang double pole, vertical, 250V
ML2031RC10	RCD, Single gang double pole, horizontal, 250V

#### Specifications

General	Description
Trip Current	10mA
Trip Time	< 40ms
Operational Voltage	250V a.c. 50Hz
Max. Load	20A
Dimensions	116 x 76mm (30mm rear projection plus wiring)
Complies with Australian Standard	AS/NZS 3190, AS/NZS 3003

#### Wiring diagram

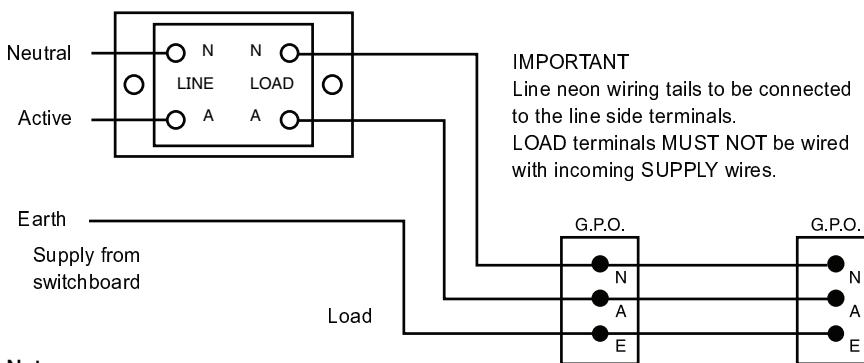

#### Note:

For further details please refer to the Installation Instructions.

#### STANDARD COLOURS

- White (WE)
- Red (RD)
- Dark Blue (DB)

## Audible/Visual Alarms

The ML2031E08 range of Audible/Visual Alarms have been developed to work in conjunction with the ML2031RC range of RCDs, and provides an audible and visual indication of when the RCD has tripped due to detection of a fault. The advantage of this product is that it provides an excellent means of alerting the hospital staff of when the RCD has actually tripped.

### Features

- Mutable two tone audible alarm indication.
- Flashing red visual alarm indication.
- Mute push button marked "PRESS TO MUTE".
- Uses the flexible Clipsal 2000 Series system.

Catalogue No.	Description
ML2031VE08	Single gang, vertical, audible/visual alarm, 250V
ML2031E08	Single gang, horizontal, audible/visual alarm, 250V

### Specifications

General	Description
Operational Voltage	250V a.c. 50Hz
Dimensions	116 x 76mm (34mm rear projection plus wiring)
Complies to Australian Standard	AS/NZS 3100, AS/NZS 3003



ML2031VE08

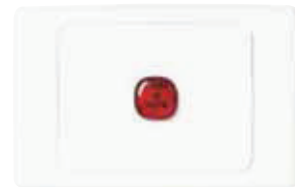

ML2031E08

### Wiring diagram

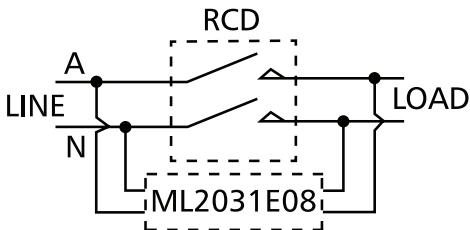

### STANDARD COLOURS

- White (WE)
- Red (RD)
- Dark Blue (DB)

### Socket Outlets

The ML2000 range of socket outlets are based on the Clipsal 2000 range of socket outlets. When installing a group of socket outlets ideally one ML2000 multi-gang plate will be used with the remaining options being standard Clipsal Socket Outlets. The one ML2000 socket outlet plate will incorporate the amber Power Available Neon, Circuit Identification, and protection classification markings for the group of socket outlets.

#### Features

- Single or twin outlet.
- Optional Clipsal 30P-ID circuit identification.

#### Socket Outlets – connected to RCD Protected Supply

- 10 or 15A.
- Single pole switched outlets.
- Marked “RCD PROTECTED”.
- Amber power available indicator.

#### Socket Outlets – connected to an isolated protected supply

- 10A.
- Double pole switched outlets.
- Marked “ISOLATING TRANSFORMER PROTECTED”.

\*Not all variations are available. Refer to catalogue number listing for exact options.

### Vertical

Catalogue No.	Description
ML2015V	Single gang power outlet, vertical, power neon, RCD label, 250V, 10A
ML2015VI	Single gang power outlet, vertical, power neon, RCD label, circuit identification, 250V, 10A
ML2015/15VI	Single gang power outlet, vertical, power neon, RCD label, circuit identification, 250V, 15A
ML2015VD	Single gang double pole power outlet, vertical, Isolated label, 250V, 10A
ML2015VDI	Single gang double pole power outlet, vertical, Isolated label, circuit identification, 250V, 10A
ML2025V	Double gang power outlet, vertical, power neon, RCD label, 250V, 10A
ML2025VI	Double gang power outlet, vertical, power neon, RCD label, circuit identification, 250V, 10A



ML2015V



ML2015VI



ML2015/15VI



ML2015VD



ML2015VDI



ML2025V



ML2025VI

### STANDARD COLOURS

- White (WE)
- Red (RD)
- Dark Blue (DB)

## Socket Outlets

### Horizontal

Catalogue No.	Description
ML2015	Single gang power outlet, horizontal, power neon, RCD label, 250V, 10A
ML2015I	Single gang power outlet, horizontal, power neon, RCD label, circuit identification, 250V, 10A
ML2015/15I	Single gang power outlet, horizontal, power neon, RCD label, circuit identification, 250V, 15A
ML2015D	Single gang double pole power outlet, horizontal, power neon, Isolated label, 250V, 10A
ML2025	Double gang power outlet, horizontal, power neon, RCD label, 250V, 10A
ML2025I	Double gang power outlet, horizontal, power neon, RCD label, circuit identification, 250V, 10A

### Specifications

General	Description
Operational Voltage	250V a.c. 50Hz
Max. Load	10 or 15A
Dimensions	116 x 76mm
Complies with Australian Standard	AS/NZS 3112
Approval No.	S/1/2025 series S/1/2015 series



ML2015



ML2015/15I



ML2025



ML2015I



ML2015D



ML2025I

### STANDARD COLOURS

- White (WE)
- Red (RD)
- Dark Blue (DB)

### Cleaner Socket Outlets

The ML2000C range of socket outlets are clearly identifiable cleaner socket outlets. The cleaner socket outlets are used to connect mains powered cleaning equipment to dedicated cleaner power circuits.

#### Features

- Single or twin outlet.
- 10 or 15A.
- Single pole switched.
- Marked "CLEANING PURPOSES ONLY".
- Beige in colour.

Catalogue No.	Description
ML2015C	Single gang power outlet, horizontal, cleaner label, 250V, 10A
ML2015IC	Single gang power outlet, horizontal, cleaner label, ID Window, 250V, 10A
ML2015/15C	Single gang power outlet, horizontal, cleaner label, 250V, 15A
ML2025C	Double gang power outlet, horizontal, cleaner label, 250V, 10A

#### Specifications

General	Description
Operational Voltage	250V a.c. 50Hz
Max. Load	10 or 15A
Dimensions	116 x 76mm
Complies with Australian Standard	AS/NZS 3112, AS/NZS 3003



ML2015C



ML2015IC



ML2015/15C



ML2025C

### STANDARD COLOURS

■ Beige (BG)

## Safety shuttered socket outlet

ML25 Series - Flush Mount Moulded socket outlet for Mental Health installations, Twin power outlet comes with power available neon, safety shuttered, security screws and no removable parts.

### Features

- Tri security screws
- Safety shuttered
- No removable parts



ML25S

Catalogue No.	Description
ML25S	Twin power outlet with power available neon, safety shuttered, security screws

### Specifications

General	Description
Operational Voltage	250V a.c. 50Hz
Max. Load	10A
Dimensions	115 x 73mm
Complies with Australian Standard	AS/NZS 3112, AS/NZS 3003

## STANDARD COLOURS

- White (WE)
- Red (RD)
- Dark Blue (DB)

### Socket Outlets - RCD Protected

The ML2025RC range of RCD protected socket outlets feature twin switched socket outlets and incorporates a powerful RCD - an electronic sensing device specifically designed to protect both people and property from damage or injury, in case of an electrical fault.

The RCD constantly monitors the balance of current flow in Active and Neutral conductors of an electrical installation. Should an electrical fault develop, or if the user should come into contact with live parts, the unit will detect the imbalance and automatically cut the electrical supply, virtually eliminating the risk of electrocution from such faults.

The outlet is capable of protecting any device hard-wired directly to the LOAD terminals, any socket outlet connected 'downstream' of the LOAD terminals and any appliance plugged into a 'downstream' socket outlet.

#### Features

- 10mA trip current.
- Amber indicator marked "POWER AVAILABLE".
- Inbuilt test facility.
- Uses the flexible Clipsal 2000 Series system.



ML2025RC10



ML2025RC10C

Catalogue No.	Description
ML2025RC10	Twin power outlet with 250V 10mA RCD
ML2025RC10C	Twin power outlet, 250V 10mA RCD with cleaner label

Socket outlet specifications	Description
Nominal Operating Voltage	250V a.c.
Nominal Operating Frequency	50 Hz
Socket Outlet Maximum Load	10A per outlet 10A total load
Socket Switching Type	Single pole
RCD specifications	
RCD Type	Type II
RCD Contact Type	Double pole
Maximum Load	20A
Maximum Tripping Current	10mA
Typical Trip Time	<40ms
RCD Capability	a.c. and pulsating d.c. protection
Circuit Protection Required	Inc 3kA circuit protection by MCB or HRC fuse, 20A Max
General specifications	
Operating Temperature Range	-10 to 40°C
Operating Humidity Range	10 to 90% R.H.
Mounting Centres	84mm Australian pattern plate

#### Wiring diagram

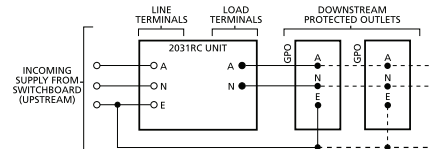

#### STANDARD COLOURS

- White (WE)
- Beige (BG)
- Red (RD)
- Dark Blue (DB)

## Equipotential Earth Studs

The ML2031R01 & ML2032R02 range of equipotential Earthing Studs have been developed to meet the relevant requirements of equipotential Earthing within hospitals.

### Features

- Single or twin equipotential stud.
- Uses the flexible Clipsal 2000 Series system.

Catalogue No.	Description
ML2031VR01	Single gang, vertical, EP stud
ML2032VR02	Double gang, vertical, EP stud
ML2031R01	Single gang, horizontal, EP stud
ML2032R02	Double gang, horizontal, EP stud

### Specifications

General	Description
Dimensions	116 x 76mm (23mm rear projection)
Complies with Australian Standard	AS/NZS 3003



ML2031VR01



ML2032VR02



ML2031R01



ML2032R02

## STANDARD COLOURS

- White (WE)
- Red (RD)
- Dark Blue (DB)

### Gas Outlet Adaptor Plate

The ML2031EU Gas Outlet Adaptor Plate has been developed to allow the ESCO MEDICON or equivalent range of gas outlets to fit to the ML2000 Series system. The blank grid plate is pre-drilled with mounting holes to allow the gas outlet to be fitted vertically or horizontally.

#### Features

- Uses the flexible Clipsal 2000 Series system.



**ML2031EU**

Catalogue No.	Description
ML2031EU	Single gang gridplate

#### Note:

The plate does not accept the ESCO MEDICON Venturi Suction and Venturi gas outlets or CIG gas outlets. It is a recommendation to use a Clipsal wall box for mounting.

---

### STANDARD COLOURS

- White (WE)

## Electrical Accessories

### Socket outlets

Catalogue No.	Description
2015V	Single gang power outlet, vertical, 250V, 10A
2015	Single gang power outlet, horizontal, 250V, 10A
2025V	Double gang power outlet, vertical, 250V, 10A
2025	Double gang power outlet, horizontal, 250V, 10A



2015V

### Switches

Catalogue No.	Description
2031VA	1 gang, vertical, switch, 250V, 10A
2032VA	2 gang, vertical, switch, 250V, 10A
2033VA	3 gang, vertical, switch, 250V, 10A
2034VA	4 gang, vertical, switch, 250V, 10A
2035VA	5 gang, vertical, switch, 250V, 10A
2036VA	6 gang, vertical, switch, 250V, 10A
2031HA	1 gang, horizontal, switch, 250V, 10A
2032HA	2 gang, horizontal, switch, 250V, 10A
2033HA	3 gang, horizontal, switch, 250V, 10A
2034HA	4 gang, horizontal, switch, 250V, 10A



2033HA

### Dimmers

Catalogue No.	Description
2032E450UD	Universal dimmer, 250V, 450W



2032VRJ



2032E450UD

### Socket outlets

Catalogue No.	Description
2031VT0	1 gang telephone outlet plate, Telstra 610 type
2031VRJ	1 gang data outlet, RJ45 Series socket mech
2032VRJ	2 gang data outlet, RJ45 Series socket mech

**Note:**

For further information regarding Electrical Accessories of the Clipsal 2000 Series please refer to the Trade Product Guide.

## STANDARD COLOURS

White (WE)

### Mounting Accessories

The ML2000 Series is based on the Clipsal 2000 Series therefore the medical service panels will incorporate some of the Clipsal 2000 Series products. Detailed below is a list of some of the more common Clipsal 2000 Series products.

#### Surrounds

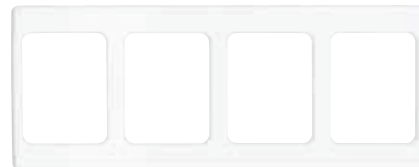

**2000/4**

Catalogue No.	Description
<b>2000</b>	1 gang, vertical, surround (116 x 76mm)
<b>2000/2</b>	2 gang, vertical, surround (116 x 144mm)
<b>2000/3</b>	3 gang, vertical, surround (116 x 219mm)
<b>2000/4</b>	4 gang, vertical, surround (116 x 290mm)
<b>2000H2</b>	2 gang, horizontal, surround (76 x 229mm)
<b>2000H3</b>	3 gang, horizontal, surround (76 x 342mm)

---

#### STANDARD COLOURS

- White (WE)
- Red (RD)
- Dark Blue (DB)

## Wall boxes

Catalogue No.	Description
157	1 gang, wall box
2157/2	2 gang, vertical, wall box
2157/3	3 gang, vertical, wall box
2157/4	4 gang, vertical, wall box
2157H2	2 gang, horizontal, wall box
2157H3	3 gang, horizontal, wall box



2157/4

## Mounting brackets (wallboard)

Catalogue No.	Description
154	1 gang, wall board mounting clip
2154/2	2 gang, vertical, wall board mounting clip
2154/3	3 gang, vertical, wall board mounting clip
2154/4	4 gang, vertical, wall board mounting clip
2154H2	2 gang, horizontal, wall board mounting clip
2154H3	3 gang, horizontal, wall board mounting clip



2154/4

## Mounting brackets (plaster mount)

Catalogue No.	Description
155P	1 gang, plaster mounted bracket
2155PRM2	2 gang, vertical, plaster mounted bracket
2155PRM3	3 gang, vertical, plaster mounted bracket
2155PRM4	4 gang, vertical, plaster mounted bracket
2155PHRM2	2 gang, horizontal, plaster mounted bracket
2155PHRM3	3 gang, horizontal, plaster mounted bracket

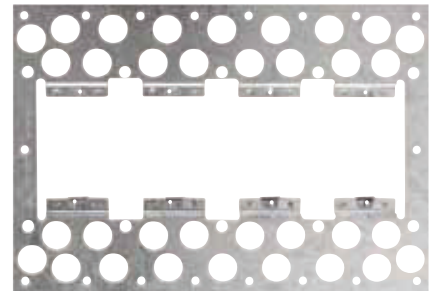

2155PRM4

### Note:

For further information regarding Mounting Accessories of the Clipsal 2000 Series please refer to the Trade Product Guide.

## STANDARD COLOURS

■ Galvanised



### Plaster mounted recessed solution

Now an impressive part of the Medilec range, the ML2165 Series is a range of flush plaster mount metal plate medical service panels.

The ML2165 Series produces a very attractive modular medical service panel system that can be assembled and installed quickly and easily.

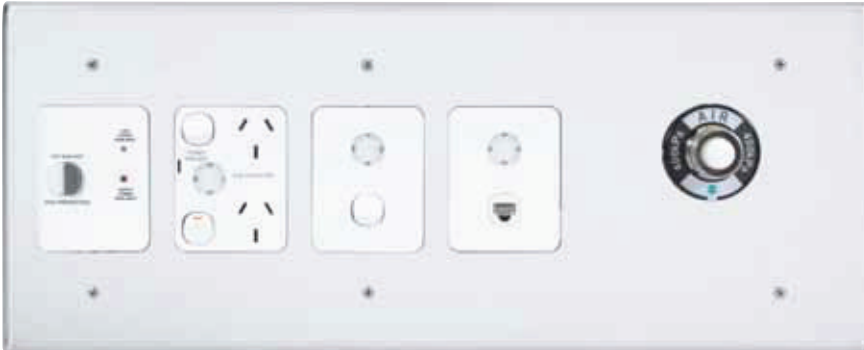

**ML2165 Series Medical Service Panel (example only)**

## Features and benefits

- The ability to integrate the extensive range of Medilec ML2000 and Clipsal 2000 Series accessories, as well as OEM 2000 Series nurse call systems and gas outlets
- Grid mounted accessories allows for individual access to each service without interruption to other services
- A choice of fascia finishes and colours, including natural high grade stainless steel and powder coated finishes
- Fast installation due to no grid height adjustment required and a simple plaster mounting system
- Can be installed post wall construction
- Can be mounted into plaster wall or timber furniture finishes easily
- Delivery of product fully assembled
- One continuous fascia for simple installation and infection control properties
- Stainless steel phillips head fixing screws for fast installation
- Provision for earthing on wall box, mounting grid and fascia
- Modular 1 to 4 gang standard components available for quick supply suitable for retrofit installations
- Ability to produce special length panels to suit customers special requirements

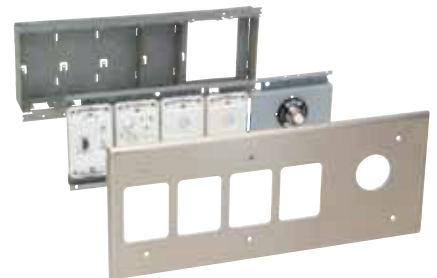

**ML2165 Expanded View**

## Customise to suit your requirements

A unique feature of the ML2165 Series is that it can be quickly and easily customised to suit the customers specifications. The system has been designed in such a way that it uses standard pre-manufactured components. It can be mounted on a continuous special designed wall box that is cut down easily to create a custom length. The advantage of this is the significant reduction in manufacturing lead times, which means a custom designed medical service panel can be supplied and installed within industry standard required time frames. The custom designed medical service panel would be delivered completely assembled and ready for immediate installation.

### Standard Modules

Medilec ML2165 Standard Modules are suited to house all Clipsal 2000 Series products, with the provision for mounting segregation between gangs. They are available in 1 to 4 gang configurations, with the option of high-grade stainless steel or powder coated finishes. All ML2165 Standard Modules are supplied complete with wall box, mounting grid and fascia.

#### Features

- Suited to house all Clipsal 2000 Series products.
- Electrical accessories mounted at 72mm centres.
- Multiple entry points.
- Provision for mounting segregation between gangs.
- Supplied complete with wall box, mounting grid and fascia.
- Also available in powder coated finishes including: "Pearl White", "Shoji White", "White Birch" or "White Satin".

Catalogue No.	Description
ML2165SS-1P	1 gang module 187mm(H) x 100mm(W) x 55mm(D)
ML2165SS-2P	2 gang module 187mm(H) x 172mm(W) x 55mm(D)
ML2165SS-3P	3 gang module 187mm(H) x 244mm(W) x 55mm(D)
ML2165SS-4P	4 gang module 187mm(H) x 316mm(W) x 55mm(D)



ML2165SS-1P

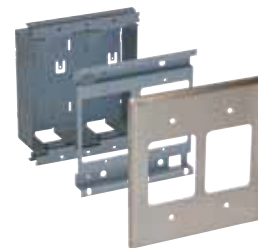

ML2165SS-2P

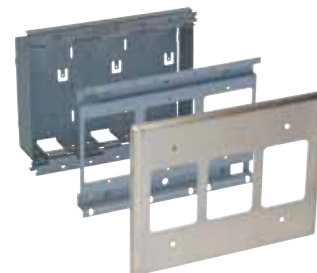

ML2165SS-3P

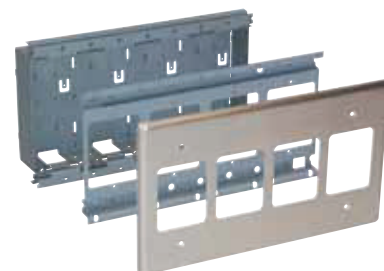

ML2165SS-4P

### STANDARD COLOURS

■ Stainless Steel

## ESCO and BOC Gas Modules

Medilec ML2165 ESCO and BOC Gas Modules have been designed to house gas valves equal to ESCO or BOC. They are available in 1 to 4 gang configurations. There are two finish options of high-grade stainless steel or powder coat finishes and all ML2165 ESCO Gas Modules are supplied complete with wall box, mounting grid and fascia.

### Features

- Suited to house gas valves equal to ESCO or BOC.
- Gas outlets mounted on 100mm centres.
- Supplied complete with wall box, mounting grid and fascia.
- Also available in powder coated finishes including: “Pearl White”, “Shoji White”, “White Birch” or “White Satin”.

### ESCO

Catalogue No.	Description
ML2165SS-1E	1 gang ESCO gas module 187mm(H) x 174mm(W) x 55mm(D)
ML2165SS-2E	2 gang ESCO gas module 187mm(H) x 318mm(W) x 55mm(D)
ML2165SS-3E	3 gang ESCO gas module 187mm(H) x 390mm(W) x 55mm(D)
ML2165SS-4E	4 gang ESCO gas module 187mm(H) x 534mm(W) x 55mm(D)

### BOC

Catalogue No.	Description
ML2165SS-1C	1 gang BOC gas module 187mm(H) x 174mm(W) x 55mm(D)
ML2165SS-2C	2 gang BOC gas module 187mm(H) x 318mm(W) x 55mm(D)
ML2165SS-3C	3 gang BOC gas module 187mm(H) x 390mm(W) x 55mm(D)
ML2165SS-4C	4 gang BOC gas module 187mm(H) x 534mm(W) x 55mm(D)



ML2165SS-1E



ML2165SS-2E

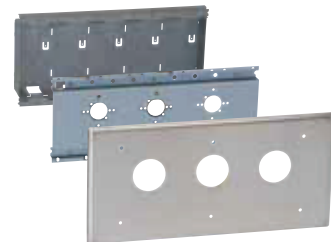

ML2165SS-3E

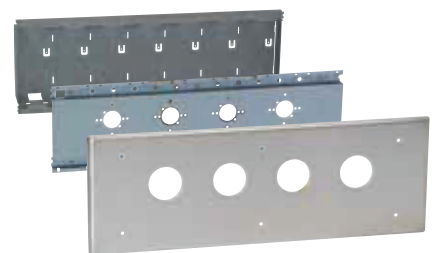

ML2165SS-4E

## STANDARD COLOURS

■ Stainless Steel

### Equipotential Junction

The equipotential junction is part of the equipotential Earthing System that is used to protect against micro shock in cardiac protected areas. The equipotential Earthing System decreases the resistance/potential differences between various earthed points within the cardiac protected area.

#### Features

- Supplied complete with wall box, mounting grid, fascia and the below components:
- 1 x BP25 line tap for bus termination.
- 4 x 8mm and 10 x 5mm diameter termination tunnels.
- 1 x equipotential Earth stud and mounting plate.
- Also available in powder coated finishes including: “Pearl White”, “Shoji White”, “White Birch” or “White Satin”.

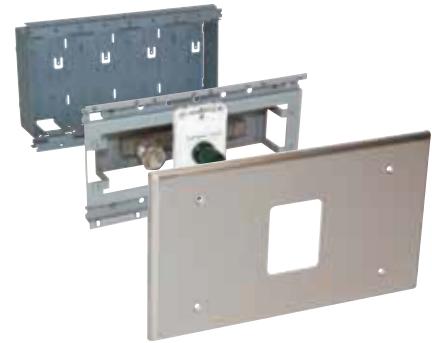

**ML2165SS-EPJ**

Catalogue No.	Description
ML2165SS-EPJ	187mm(H) x 318mm(W) x 55mm(D)

---

### STANDARD COLOURS

■ Stainless Steel

---

## Installation Instructions

### Wall Box Installation

The metal wall box is mounted within the wall cavity, through a cut out in the plaster board to the equal size of the wall box, (wall must be framed to allow panel size) the box is then fixed to the plaster via mounting brackets that are attached to the back of the wall box, they are lifted up and pushed back to the underside of the plaster wall. Screws are then put through the front of the wall box and through to the bracket behind to achieve plaster fixing.

If required, it is recommended that the Medilec segregation barriers be installed prior to the wall box installation.

### Grid Installation

The metal grid plate is mounted to the wall box via four screws, which are fixed to each corner of the grid. There are no adjustments required with this product.

There are different grids required for Clipsal 2000 Series accessories and gas outlets, the gas grid plates allow for installation of both ESCO and CIG outlets with or without a scavenge.

### Clipsal 2000 Series Accessories Installation

Each Clipsal 2000 Series accessory is installed onto the grid with two screws.

When fixing the 2000 Series accessories to the grid, back the screws off slightly to allow the 2000 Series accessory to move from side to side.

It is recommended that for easier installation, the Clipsal 2000 Series accessories are mounted to the grid prior to the grid being mounted to the wall box.

### Fascia Installation

The fascia is fixed to the grid with two or four countersunk screws.

A slight adjustment of the positioning of the accessories may be necessary to align them up with the cut outs within the fascia.



### Stud mounted flush solution

Now an impressive part of the Medilec range, the ML2164 Series is a range of flush mount metal plate medical service panels.

The ML2164 Series produces a very attractive modular medical service panel system that can be assembled quickly and easily.

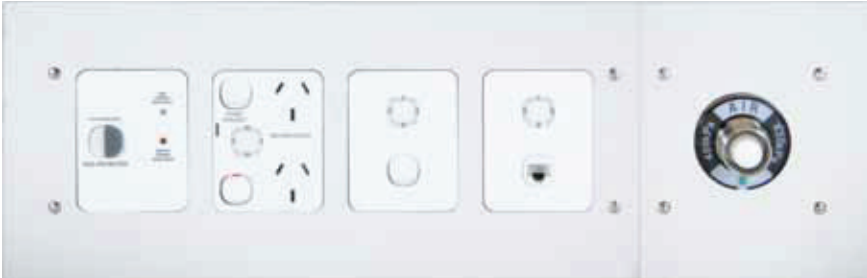

**ML2164 Series medical service panel**

## Features and benefits

- The ability to integrate the extensive range of Medilec ML2000 and Clipsal 2000 Series accessories, as well as OEM 2000 Series nurse call systems and gas outlets
- Grid mounted accessories allow for individual access to each service without interruption to other services
- A choice of fascia finishes and colours, including natural high grade stainless steel and powder coated finishes
- Adjustable grid height, to allow easy positioning of accessories flush with the wall surface
- Modular 1 to 4 gang components can quickly be assembled together to produce special length panels to suit the customers requirements, therefore there is a significant reduction in delivery times

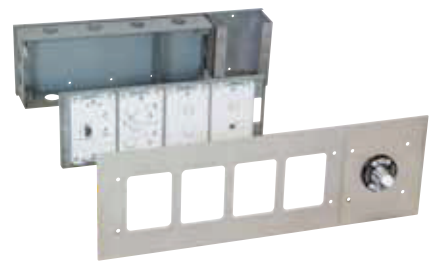

**ML2164 Expanded View**

## Customise to suit your requirements

A unique feature of the ML2164 Series is that it can be quickly and easily customised to suit the customers specifications. The system has been designed in such a way that the standard components can be joined together to produce a custom medical service panel. The advantage of this is the significant reduction in delivery times, which means the wall box assembly, grids and accessories can be supplied and installed almost immediately. The only item required to finish the installation would be the custom manufactured fascia which would be supplied shortly after.

### Wall Boxes

Medilec ML2164 Wall Boxes have been innovatively designed so they can be joined together using the ML2164JT Joining Tray if greater length is required. Multiple entry points are also provided to accommodate cabling and they are available in 1 to 4 gang configurations.

#### Features

- Adjustable grid height allows easy positioning of accessories flush with the wall surface. The front face of the wall box can be mounted between 0 to 30mm behind the wall surface.
- Multiple entry points.
- Provision for mounting segregation between gangs.
- When a longer panel is required the standard wall boxes have been designed so that they can be easily joined together using the ML2164JT Joining Tray.

Catalogue No.	Description
ML2164/1W	1 gang wall box 120mm(H) x 104mm(W) x 65mm(D)
ML2164/2W	2 gang wall box 120mm(H) x 176mm(W) x 65mm(D)
ML2164/3W	3 gang wall box 120mm(H) x 248mm(W) x 65mm(D)
ML2164/4W	4 gang wall box 120mm(H) x 320mm(W) x 65mm(D)



ML2164/1W



ML2164/2W



ML2164/3W



ML2164/4W

### STANDARD COLOURS

■ Galvanised

## Grids

Medilec ML2164 Grids accommodate all ML200 and Clipsal 2000 Series accessories, including OEM 2000 Series nurse call systems and gas outlets. Grids are available in 1 to 4 gang configurations and provide adjustable grid height to allow for easy positioning of accessories.

### Features

- Adjustable grid height to allow easy positioning of accessories flush with the wall surface.
- Provision for mounting segregation between gangs.
- Electrical accessories mounted on 72mm centres.
- Accommodates all Medilec ML2000 and Clipsal 2000 Series accessories, as well as OEM 2000 Series nurse call systems and gas outlets.

Catalogue No.	Description
ML2164/1G	1 gang grid 117mm(H) x 100mm(W) x 12mm(D)
ML2164/2G	2 gang grid 117mm(H) x 172mm(W) x 12mm(D)
ML2164/3G	3 gang grid 117mm(H) x 244mm(W) x 12mm(D)
ML2164/4G	4 gang grid 117mm(H) x 316mm(W) x 12mm(D)



ML2164/1G



ML2164/2G



ML2164/3G



ML2164/4G

## STANDARD COLOURS

■ Galvanised

### Equipotential Junction

The Equipotential (EP) Junction is part of the equipotential Earthing System that is used to protect against micro shock in cardiac protected areas. The equipotential Earthing System decreases the resistance/potential differences between various earthed points within the cardiac protected area.

#### Features

- Adjustable grid height to allow easy positioning of the Equipotential Junction flush with the wall surface.
- 1 x BP25 line tap for bus termination.
- 4 x 8mm and 10 x 5mm diameter termination tunnels.
- 1 x equipotential Earth stud.



**ML2164E35**

Catalogue No.	Description
<b>ML2164E35</b>	14 tunnels and 1 line tap (suit 3 gang wall box). Equipotential junction grid assembly 117mm(H) x 224mm(W) x 60mm(D)

---

### STANDARD COLOURS

- White
- Galvanised (Grid Assembly)

## Fascias

Medilec ML2164 Fascias come in a choice of powder coat finish and natural high-grade stainless steel. They are available in 1 to 4 gang configurations and can accommodate ML2000 and Clipsal 2000 Series accessories, as well as OEM 2000 Series nurse call systems and gas outlets.

### Features

- A choice of fascia finishes and colours, including natural high grade stainless steel and powder coated finishes.
- Electrical accessories mounted on 72mm centres.
- Gas outlets mounted on 108mm centres.
- Accommodates all Medilec ML2000 and Clipsal 2000 Series accessories, as well as OEM 2000 Series nurse call systems and gas outlets.

### Standard

Catalogue No.	Description
ML2164/1F	1 gang fascia 150mm(H) x 136mm(W)
ML2164/2F	2 gang fascia 150mm(H) x 208mm(W)
ML2164/3F	3 gang fascia 150mm(H) x 280mm(W)
ML2164/4F	4 gang fascia 150mm(H) x 352mm(W)

### Gas

Catalogue No.	Description
ML2164/1FE2	1 gang ESCO gas fascia
ML2164/2FE2	2 gang ESCO gas fascia
ML2164/3FE2	3 gang ESCO gas fascia
ML2164/1FC2	1 gang BOC gas fascia
ML2164/2FC2	2 gang BOC gas fascia
ML2164/3FC2	3 gang BOC gas fascia

### Equipotential Junction

Catalogue No.	Description
ML2164E35F	1 gang equipotential fascia 150mm(H) x 280mm(W) suit 3 gang wall box



ML2164/1F

ML2164/2F



ML2164/3F



ML2164/4F

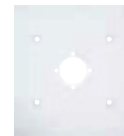

ML2164/1FE2



ML2164/2FE2



ML2164/3FE2



ML2164E35F

## STANDARD COLOURS

■ Stainless Steel

### Accessories

Customised Medilec Service Panels that are longer than the standard 1 to 4 gang ML2164 components will typically be supplied pre-assembled, but it is possible for the customer to develop their own customised panels by using the ML2164 accessories.

Catalogue No.	Description
<b>ML2164FMB</b>	Fascia mounting bracket
<b>ML2164JP</b>	Wall box joining tray joiner plate
<b>ML2164JT</b>	Wall box joining tray 2400mm
<b>ML2164S</b>	Segregation
<b>ML2164GMB</b>	Gas fascia mounting bracket (1 pair)
<b>ML2164JP2</b>	Wall box joining plate



**ML2164FMB**

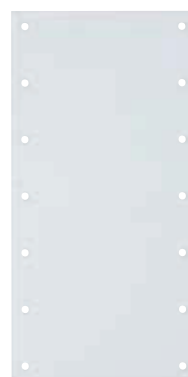

**ML2164JP**

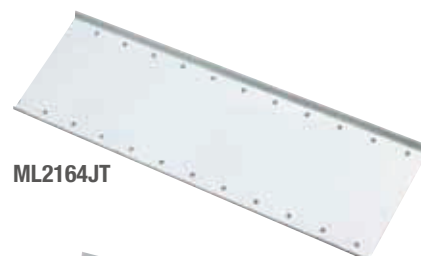

**ML2164JT**



**ML2164S**

### STANDARD COLOURS

■ Galvanised

---

## Installation Instructions

### Wall Box Installation

The metal wall box must be mounted within the wall cavity so that the front face of the wall box is recessed between 0mm to 30mm from the front face of the wall.

If required, it is recommended that the Medilec segregation barriers be installed prior to the wall box installation.

### Grid Installation

The metal grid plate is mounted to the wall box via four height adjustable screws, which are fixed to each corner of the grid. The grid is placed onto the wall box and the height adjuster screws are screwed into the four brackets located in each corner of the wall box. The grid height is then adjusted so that the front lip of the grid sits between 0mm to 0.5mm below the front face of the wall. Adjusting the height of the grid is carried out by rotating each of the mounting height adjuster screws.

If the screws are not already installed onto the grid then place each of the screws into the 4.5mm holes located in the corners of the grid. The brass nuts are then wound up hard against the head of the screw, making sure that the nuts have been assembled the correct way to allow the screws to freely rotate.

### Clipsal 2000 Series Accessories Installation

Each Clipsal 2000 Series accessory is installed onto the grid with two screws.

When fixing the Clipsal 2000 Series accessories to the grid, back the screws off slightly to allow the Clipsal 2000 Series accessory to move from side to side.

It is recommended that for easier installation, the Clipsal 2000 Series accessories are mounted to the grid prior to the grid being mounted to the wall box.

### Fascia Installation

The fascia is installed to the grid with four counter sunk screws.

A slight adjustment of the positioning of the accessories may be necessary to align them up with the cut outs within the fascia.



### Surface mounted duct solution

Now an impressive part of the Medilec Range, the MLH921 Series is a range of surface mount extruded aluminium plate medical service panels. The MLH921 Series is designed to incorporate the Medilec ML2000 and Clipsal 2000 Series range of electrical accessories, as well as the various OEM products based on the Clipsal 2000 Series format, which include nurse call systems and gas outlets.

The MLH921 Series produces a very attractive modular medical service panel system that can be assembled and installed quickly and easily.



**MLH921 Assembled**

## Features and benefits

- Can integrate the Medilec ML2000 and Clipsal 2000 Series accessories, as well as OEM 2000 Series nurse call systems and gas outlets
- Shroud mounted accessories allows for individual access to each service without interruption to other services
- A choice of powder coated colours and finishes
- Fast installation, due to using modular components designed to mitigate and reduce alignment accuracy
- Purchased in components allowing on-site assembly
- Can be installed post-wall construction
- Can be mounted onto plaster wall or timber furniture finishes easily
- Can be purchased fully assembled and supplied in one delivery
- Services can be relocated or moved without affecting segregation or requiring special components
- Additional services can be added post-installation
- Incorporates three segregated service channels
- Continuous segregation between ELV & LV services
- Reduction of dust collection due the chamfered face of the duct
- Snap on fascias and lid mechanism for quick installation and removal
- No surface mounting screws providing increased infection control properties
- Ability to produce special length panels to suit customers special requirements



**MLH921 Expanded**

## Customise to suit your requirements

A unique feature of the MLH921 Series is that it can be quickly and easily customised to suit the customers specifications. The system has been designed in such a way that it uses standard pre-manufactured components that can be mounted on a continuous special designed extruded duct that is cut down easily to create a custom length. The advantage of this is the significant reduction in manufacturing lead times, which means a custom designed medical service panel can be supplied and installed in industry standard required time frames. The costumed designed medical service panel can be delivered completely assembled and ready for immediate installation or supplied as components for on-site assembly providing maximum flexibility.

### Standard Modules

Medilec MLH921 Standard Modules are suited to house all Clipsal 2000 Series products, with the provision for mounting segregation between gangs. They are available in 1 to 4 gang configurations and powder coated finishes. All MLH921 Standard Modules provide multiple cable entry points and are supplied complete with shroud, fixings and corresponding fascia.

#### Features

- Suited to house all Clipsal 2000 Series products.
- Electrical accessories mounted at 72mm centres.
- Multiple entry points.
- Provision for mounting segregation between shrouds.
- Supplied complete with shroud, fixings and corresponding fascia.
- Available in all Dulux powder coated colours.

Catalogue No.	Description
MLH921-1P	1 gang module 72mm(W) comes with shroud, fixings and corresponding fascia
MLH921-2P	2 gang module 144mm(W) comes with shroud, fixings and corresponding fascia
MLH921-3P	3 gang module 216mm(W) comes with shroud, fixings and corresponding fascia
MLH921-4P	4 gang module 288mm(W) comes with shroud, fixings and corresponding fascia



MLH921-1P



MLH921-2P

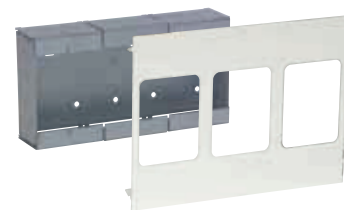

MLH921-3P

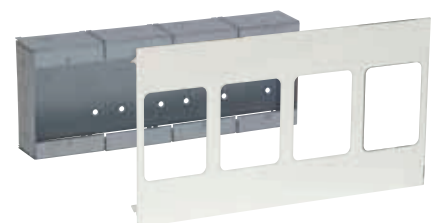

MLH921-4P

### STANDARD COLOURS

- Pearl White
- Shoji White
- White Birch
- White Satin

## Equipotential Junction Module

The Equipotential Junction is part of the equipotential Earthing system that is used to protect against micro shock in cardiac protected areas. The equipotential Earthing System decreases the resistance or potential differences between various earthed points within the cardiac protected area.

### Features

- Supplied complete with duct, blank ends, mounting shroud and facia.
- 1 x BP25 line tap for bus termination.
- 4 x 8mm and 10 x 5mm diameter termination tunnels.
- 1 x Equipotential Earth stud and mounting plate.
- Available in all Dulux powder coated colours.



MLH921-EPJ

Catalogue No.	Description
MLH921-EPJ	210mm(H) x 223mm(W) x 90mm(D). 14 tunnels and 1 line tap.

### STANDARD COLOURS

- Pearl White
- Shoji White
- White Birch
- White Satin

### ESCO and BOC Gas Modules

Medilec MLH921 ESCO and BOC Gas Modules have been designed to house gas valves equal to ESCO. They are available in 1 to 4 gang configurations. There is a choice of four powder coat finishes and all MLH921 ESCO Gas Modules are supplied complete with shroud, fixings and corresponding fascia.

#### Features

- Suited to house gas valves equal to ESCO or BOC.
- Gas outlets mounted on 105mm centres.
- Supplied complete with shroud, fixings and corresponding fascia.
- Available in all Dulux powder coated colours.

#### ESCO

Catalogue No.	Description
MLH921-1E	1 gang ESCO gas module 138mm(W) comes with shroud, fixings and corresponding fascia
MLH921-2E	2 gang ESCO gas module 243mm(W) comes with shroud, fixings and corresponding fascia
MLH921-3E	3 gang ESCO gas module 348mm(W) comes with shroud, fixings and corresponding fascia
MLH921-4E	4 gang ESCO gas module 486mm(W) comes with shroud, fixings and corresponding fascia

#### BOC

Catalogue No.	Description
MLH921-1C	1 gang CIG gas module 138mm(W) comes with shroud, fixings and corresponding fascia
MLH921-2C	2 gang CIG gas module 243mm(W) comes with shroud, fixings and corresponding fascia
MLH921-3C	3 gang CIG gas module 348mm(W) comes with shroud, fixings and corresponding fascia
MLH921-4C	4 gang CIG gas module 486mm(W) comes with shroud, fixings and corresponding fascia



MLH921-1E

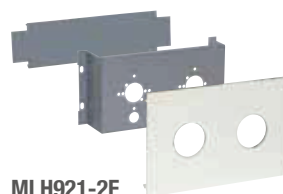

MLH921-2E



MLH921-3E

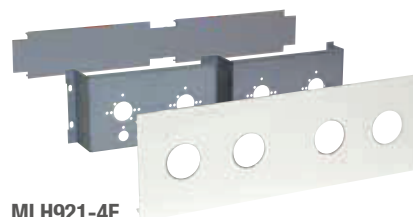

MLH921-4E



MLH921-4C

#### STANDARD COLOURS

- Pearl White
- Shoji White
- White Birch
- White Satin

## Duct, Lid & Accessories

As well as having the services panel supplied completely assembled, the unique design of the MLH921 product allows for each services component and duct to be purchased individually and assembled on-site to suit every customers special requirements. Duct and lid can be cut to size and components mounted within to suit the desired length. The duct can be mitred for internal and external corners (please note: sharp edges may result from external mitring). You can also use a three channel skirting duct for riser access for areas without cavity voids for cable entry.

### Features

- Three segregated service channels.
- Snap on lid fixing mechanism.
- Easy fit joining plates.
- 4mm cover incorporated within blank ends.
- Available in all Dulux powder coated colours.

Catalogue No.	Description
MLH921D	1 length of duct 210mm(H) x 2400mm(L) x 90mm(D)
MLH921L	1 length of lid 156mm(H) x 1200mm(L) x 13mm(D)
MLH921SP	Internal segregation plate
MLH921EP	Equipotential joining plates
MLH921BE	Blank end
LAPLT70G	Internal LV segregation plastic cover - 3000mm length
5900900	Lid removal tool

MLH921D



MLH921L



MLH921SP

MLH921BE



MLH921EP



LAPLT70G



5900900

## STANDARD COLOURS

- Pearl White
- Shoji White
- White Birch
- White Satin

### Installation Instructions

#### **Surface Mounted Duct Installation**

The extruded surface mounted duct is mounted directly to the wall finished surface by use of screw fixings (supplied by others) directly into a solid section of the wall construction. There are two grooves extruded into the inside of the duct above and below the centre channel that are recommended to be used as the fixing location, this will give the best result in ensuring the snap on fascias will have the correct resistance for solid installation.

The duct can be mounted upside down or back to front, all fixing points and channels are centrally located to avoid incorrect mounting location. When joining two lengths of duct together you must use the MLH921EP plates supplied, these are mounted both top, bottom and in the centre of the duct, the centre plate has two screw fixings to ensure earthing continuity.

#### **Shroud Installation**

The metal internal shrouds are mounted inside the extruded duct via four supplied mounting screws, the pre-punched holes in the back of the shroud will be in line with a extruded fixing channels in the centre of the duct to ensure the correct alignment and mounting location of the shroud.

Shrouds must be mounted hard up against each other when mounting together, there is a laser cut edge on each side of the shrouds to assist with the correct alignment. Each Clipsal 2000 Series shroud is supplied with fixing screws for sockets and earth tail.

Gas shrouds are a 'top hat' design and are also mounted using the centre extruded channels, all gas shrouds are designed to mount both ESCO and CIG valves and have punch outs for scavenge locations. The shroud allows for the gas piping to enter from the top or bottom of the extruded duct without infringement, each shroud is supplied with a matching snap on plastic centre segregation cover that covers the LV centre channel maintaining continuous segregation between ELV & LV services.

## Installation Instructions

### **Blank End Installation**

The blank ends have been designed to fit over the ends of the extruded duct, this design allows for 2mm over and under cover between the end of the duct and fascia installation. There are four screws required to mount the blank end on the ends of the duct, each blank end has four pre-drilled counter sunk holes that match four extruded fixing channels. Please note that the blank ends are made from galvanized sheet metal and this could result in the powder coated colour being a slightly different shade than the aluminium extruded duct.

### **Clipsal 2000 Accessories Installation**

Each Clipsal 2000 Series accessory is installed onto the shroud with two screws. When fixing the Clipsal 2000 Series accessories to the shroud, back the screws off slightly to allow the Clipsal 2000 Series accessory to move from side to side.

### **Fascia Installation**

The fascia is fixed to the duct via a snap on mechanism that can be easily removed with a plastic tool. This unique design removes the requirement for any surface fixing screws providing increased infection control and fast installation. Each fascia has been designed to be of equal size to the corresponding shroud minimising any alignment inaccuracy.

### **Segregation Installation**

The segregation is made of one metal plate. The segregation plate is screwed into the centre of the shrouds via pre-drilled holes and supplied screws, each shroud has a slot through the top plate to allow the segregation plate to mount between services in the correct location.



### Custom timber solution

Now an impressive part of the Medilec range, the ML2144 Series is a range of mounting brackets that allow the Medilec ML2164 flush metal plate medical service panels to fit onto surface mounted joinery (not supplied). The resulting surface mounted medical service panel system is an economical system that allows the designer to develop whatever joinery profile they require.



**ML2144 Series medical service panel**

## Features and benefits

- Economical when compared to other surface mount medical service panel systems
- Limitless joinery/enclosure designs due to the flexibility of using MDF or equivalent material
- Standard modular 1 to 4 gang fascias can butt together, either horizontally or vertically, to produce special length/height panels
- The ability to integrate the extensive range of modular Medilec ML2000 and Clipsal 2000 Series accessories, as well as OEM 2000 Series nurse call systems and gas outlets
- Grid mounted accessories allows for individual access to each accessory
- A choice of fascia finishes and colours, including natural high grade stainless steel and powder coated finishes
- Surface mounted systems provide better acoustic and fire rating characteristics than a recessed system
- Surface mounted systems provide less wall preparation than a recessed system, which can interfere with internal wall studs, especially if long panels are required
- Surface mounted systems provide an easy means to cover existing wall cavities in retrofit installations, especially if walls are of brick construction

**Note:**

The ML2144 system does not provide segregation or cable channels for cable distribution



**ML2144 medical service panel construction**

### Mounting Brackets

Standard 1 to 4 gang fascias can either be butted together or spaced apart, to produce special length fascias. If they are required to be butted together, then simply butt together the corresponding ML2144 mounting brackets, as they are the same size as the fascia.

#### Features

- The 1 to 4 gang brackets are the same size as the corresponding fascias. Brackets can quickly and easily be butted together horizontally or vertically, which in turn butts together the fascias to produce special length/height panels.
- The central cut of the bracket is the same dimension as the grid that will be mounted to it, therefore the cut-out can be used as a guide to make sure the enclosure cut-out is of adequate size to allow the grid to fit.

Bracket	Dimensions
ML2144/1	150mm(H) x 135.5mm(W)
ML2144/2	150mm(H) x 207.5mm(W)
ML2144/3	150mm(H) x 279.5mm(W)
ML2144/4	150mm(H) x 351.5mm(W)

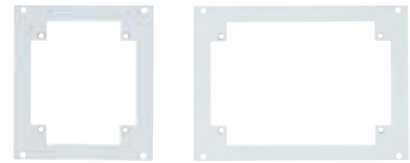

ML2144/1

ML2144/2



ML2144/3



ML2144/4

### Grids

Medilec ML2144 Grids accommodate all ML2000 and Clipsal 2000 Series accessories, including OEM2000 Series nurse call systems and gas outlets. Grids are available in 1 to 4 gang configurations and provide adjustable grid height to allow for easy positioning of accessories.

#### Features

- Adjustable grid height to allow easy positioning of accessories flush with the wall surface.
- Provision for mounting segregation between gangs.
- Electrical accessories mounted on 72mm centres.
- Accommodates all Medilec ML2000 and Clipsal 2000 Series accessories, as well as OEM 2000 Series nurse call systems and gas outlets.

Catalogue No.	Description
ML2164/1G	1 gang grid 117mm(H) x 100mm(W) x 12mm(D)
ML2164/2G	2 gang grid 117mm(H) x 172mm(W) x 12mm(D)
ML2164/3G	3 gang grid 117mm(H) x 244mm(W) x 12mm(D)
ML2164/4G	4 gang grid 117mm(H) x 316mm(W) x 12mm(D)



ML2164/1G

ML2164/2G



ML2164/3G



ML2164/4G

### STANDARD COLOURS

- Galvanised

## Fascias

Medilec ML2144 Fascias come in a choice of colours and finishes, including natural high-grade stainless steel. They are available in 1 to 4 gang configurations and can accommodate ML2000 and Clipsal 2000 Series accessories, as well as OEM2000 Series nurse call systems and gas outlets.

### Features

- A choice of fascia finishes and colours including natural high grade stainless steel and powder coated finishes.
- Electrical accessories mounted on 72mm centres.
- Accommodates all Medilec ML2000 and Clipsal 2000 Series accessories, as well as OEM 2000 Series nurse call systems and gas outlets.

### Standard

Catalogue No.	Description
ML2164/1F	1 gang fascia 150mm(H) x 135.5mm(W)
ML2164/2F	2 gang fascia 150mm(H) x 207.5mm(W)
ML2164/3F	3 gang fascia 150mm(H) x 279.5mm(W)
ML2164/4F	4 gang fascia 150mm(H) x 351.5mm(W)

### Gas - Stainless Steel Facias

#### ESCO

Catalogue No.	Description
ML2164/1FE2	1 gang ESCO gas fascia 150mm(H) x 135.5mm(W) suit 1 gang mounting bracket
ML2164/2FE2	2 gang ESCO gas fascia 150mm(H) x 279.5mm(W) suit 2 gang mounting bracket
ML2164/3FE2	3 gang ESCO gas fascia 150mm(H) x 351.5mm(W) suit 3 gang mounting bracket

#### BOC

Catalogue No.	Description
ML2164/1FC2	1 gang BOC gas fascia 150mm(H) x 135.5mm(W) suit 1 gang mounting bracket
ML2164/2FC2	2 gang BOC gas fascia 150mm(H) x 279.5mm(W) suit 2 gang mounting bracket
ML2164/3FC2	3 gang BOC gas fascia 150mm(H) x 351.5mm(W) suit 3 gang mounting bracket

### Equipotential Junction

Catalogue No.	Description
ML2164E35F	1 gang equipotential fascia 150mm(H) x 280mm(W) suit 3 gang wall box



ML2164/1F

ML2164/2F



ML2164/3F



ML2164/4F

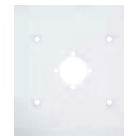

ML2164/1FE2



ML2164/2FE2

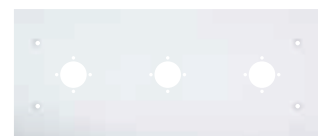

ML2164/3FE2



ML2164E35F

## STANDARD COLOURS

■ Stainless Steel

### Equipotential Junction

To protect against micro shock in Cardiac Protected Areas, Medilec offer an equipotential junction. The equipotential junction Earthing System decreases the resistance or potential differences between various earth points within the cardiac protection area.

#### Features

- Adjustable grid height to allow easy positioning of the equipotential junction flush with the wall surface.
- 1 x BP25 line tap for bus termination.
- 4 x 8mm and 10 x 5mm diameter termination tunnels.
- 1 x equipotential Earth stud.



**ML2164E35**

Catalogue No.	Description
ML2164E35	Equipotential junction grid assembly 117mm(H) x 244 mm(W) x 60mm(D) suits 3 gang bracket, 14 tunnels and 1 line tap.

---

### STANDARD COLOURS

- White
- Galvanised (Grid Assembly)

## Installation Instructions

The surface mount joinery (not supplied) enables the architect limitless enclosure designs, due to the flexibility of using MDF or an equivalent material. For instance, individual panels can be mounted end-to-end on a long length of horizontal joinery or they can be mounted top to bottom on vertical joinery.

Architects and Joinery Manufacturers must follow these simple guidelines when designing and manufacturing the MDF enclosure.

### Enclosure dimensions:

- A. MDF material thickness - 18mm (min).
- B. Enclosure height (internal) - 155mm (min).
- C. Enclosure depth - 55mm (min).

### There are two exceptions to these limitations:

- If wiring and gas piping are to run within the enclosure rather than the wall, then the height and depth dimensions will need to increase.
- The depth will reduce if an alternative semi-recessed enclosure is used which consists of only the 18mm (min) MDF panel mounted directly to the wall surface. The accessories being semi-recessed into the wall.

**Prior to the enclosure being mounted to the wall the ML2144 mounting brackets will need to be screwed to the rear of the enclosure. Refer to the following points for correct installation:**

- Standard 1 to 4 gang fascias can either be butted together or spaced apart to produce special length fascias. If they are required to be butted together then simply butt together the corresponding ML2144 mounting brackets, as they are the same size as the fascia.
- Prior to the brackets being installed onto the enclosure, each bracket will require a cut-out in the enclosure for the grid assembly to fit within (refer to table). A handy feature incorporated into the mounting bracket design is the central cut out. It is the same dimension as the grid that will be mounted to the bracket, therefore it can be used as a guide to make sure the enclosure cut-out is of adequate size.

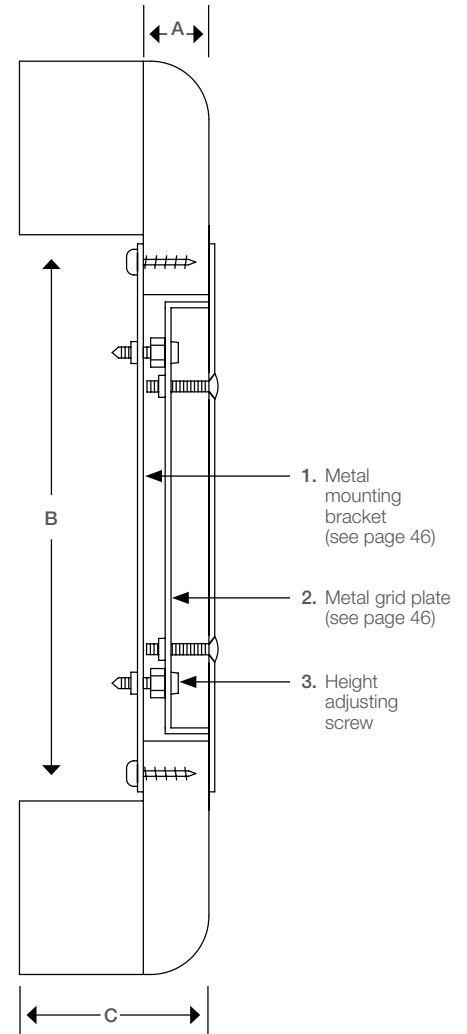



### Premium electronic safety products

Before becoming part of Health Solutions, the company Electronic Safety Products (ESP) was one of Australia's leading designers and manufacturers of equipment which provides a high level of protection against electrocution.

Since the 1970s ESP was involved with the design, development and manufacture of Residual Current Devices (RCDs), Line Isolation and Overload Monitors (LIOMs), and Medical Service Panels suitable for use in patient treatment areas.

The ESP product range and expertise continues within Health Solutions and now comprises of a range of electrocution protection equipment, various styles of medical service panel systems, and a large range of accessories specifically developed to meet the requirements of patient treatment areas in hospitals.

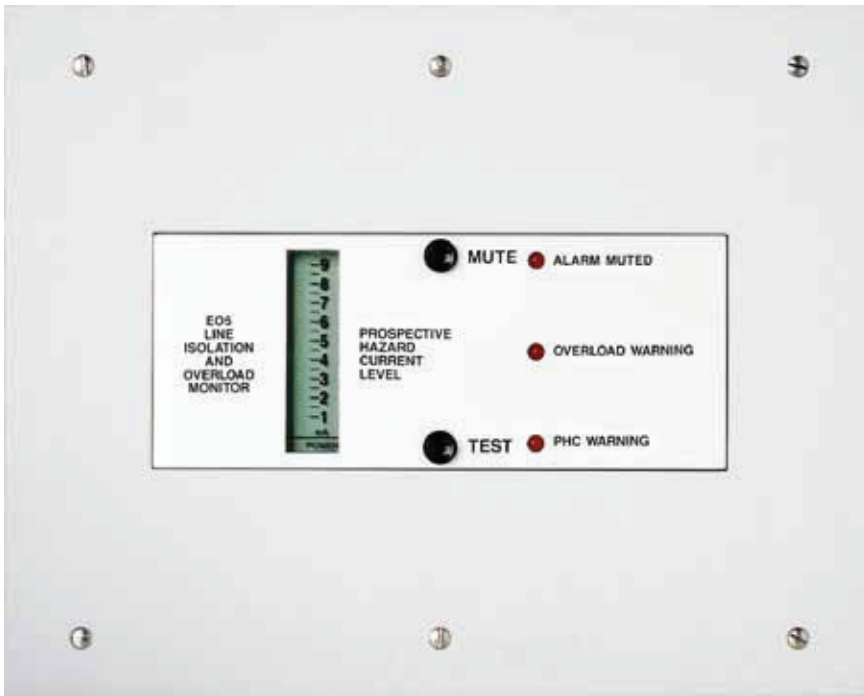

## Features and benefits

- Robust design
- Widely used in hospital theatre applications
- Custom made three phase panels available (16A – 100A)
- Incorporates a flush mount fascia that fits to a recessed wall box
- Accessories are typically mounted directly to the fascia
- Wall box incorporates height adjusters, to allow the wall box to be roughly fitted then adjusted to sit flush with the front face of the wall
- Standard finish is stainless steel, but can be powder coated upon request
- Available in four sizes

### Wall Boxes

The ESP WB Series of recessed wall boxes are used to mount all flush mount ESP series medical service panels.

#### Installation

- Prior to installing the wall box make sure it is correctly orientated i.e. the height of a standard wall box is 198mm.
- Punch out the required number of wall box wiring entry knock outs.
- Fit the wall box within the wall. The depth of the wall box is not critical as long as at the end of the installation the adjustable height panel fixing points can be adjusted so that they are flush with the finished wall surface.
- When the wall construction is finalised, adjust the panel fixing points with an allen key so that they are flush with the finished wall surface. Adjustment of the panel fixing points can also be done when installing the panel. Simply hold the panel in position and wind out the panel fixing points by inserting the allen key through the panel mounting holes.

Catalogue Number	Description
WB2	2 module wall box, dimension: 198mm(H) x 150mm(W) x 70mm(D), for Fascias, 220mm(H) x 175mm(W)
WB4	4 module wall box, dimension: 198mm(H) x 250mm(W) x 70mm(D) for Fascias, 220mm(H) x 275mm(W)
WB6	6 module wall box, dimension: 198mm(H) x 400mm(W) x 70mm(D) for Fascias, 220mm(H) x 425mm(W)
WB8	8 module wall box, dimension: 198mm(H) x 500mm(W) x 70mm(D) for Fascias, 220mm(H) x 525mm(W)



WB2



WB4



WB6

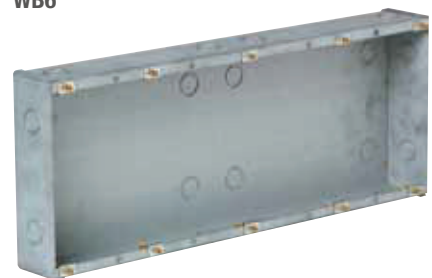

WB8

### STANDARD COLOURS

■ Galvanised

## Combination RCD/MCBs

The E01 Series combination RCD/MCBs provide electrocution and overload protection. This product is available as an individual module or incorporated within the ESP Series Medical Service Panels (MSPs).

### Features

- 10mA trip current.
- Overload protection.
- Blue line supply indicator and amber load supply indicator.
- In-built indicator to indicate whether an RCD or MCB fault has occurred.
- In-built test facility.
- Modular DIN rail mounted design.
- Sophisticated filtering to stop nuisance tripping caused by radio frequency interference (RFI).

Catalogue No.	Description
E01CNN*	RCD/MCB Module
E01*/2	Flush Mount RCD/MCB

### Note:

- Replace “\*” within the catalogue number with either 10, 16, 20 or 32 depending on the overload rating.
- If flush mounted the corresponding recessed wall box is catalogue number WB2.

### Specifications

General	Description
Trip Current	10mA
Trip Time	< 40ms
Operational Voltage	240V a.c. 50Hz
Overload Rating	10, 16, 20 or 32A
Operating Temp.	-10°C to +55°C
Dimensions	Flush Mount – 220mm(H) x 175mm(W) x 70mm(D)
Standard Finishes	Module – WE – White Electric Flush Mount – Stainless steel

### Wiring diagram

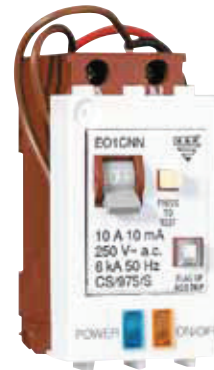
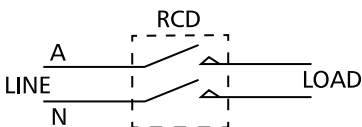

E01CNN10



E01/10/2

## STANDARD COLOURS

- White (WE) (Module)
- Stainless Steel (Flush Mount)

### Audible/Visual Alarm Module

The E08M Series Audible Alarm is used in conjunction with the E01 Series combination RCD/MCB. It is used to provide audible and visual indication of when the RCD it is monitoring trips.

The E08M Series Audible Alarm is available as an individual module or is combined with the E01 Series combination RCD/MCB and incorporated within the ESP Series medical service panels (MSPs).

#### Features

- Multiple 2 tone audible indication.
- Flashing red visual alarm indicator.
- Mute push-button marked "PRESS TO MUTE".
- Remote alarm contacts.
- Modular DIN rail mounted design.

Catalogue No.	Description
E08M	Audible Alarm Module
E02/*/2	Flush Mount Audible Alarm and combined RCD/MCB

#### Note:

- Replace "\*" within the catalogue number with either 10, 16, 20 or 32 depending on the RCD/MCB overload rating.
- If Flush Mounted then the corresponding recessed wall box is catalogue number WB2.

#### Specifications

General	Description
Operational Voltage	240V a.c. 50Hz
Audible Alarm	74 dB typical at 1 metre
Remote Alarm Contacts	Volt free, changeover, 5A/240V relay contacts
Trip Current	10mA (RCD/MCB only)
Trip Time	< 40ms (RCD/MCB only)
Overload Rating	10, 16, 20 or 32A (RCD/MCB only)
Operating Temp.	-10°C to +55°C
Dimensions	Flush Mount – 220mm(H) x 175mm(W) x 70mm(D)



E08M



E02/10/2

#### Wiring diagram

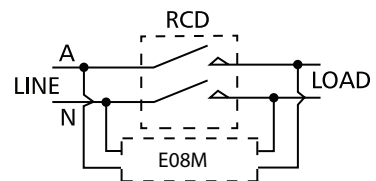

### STANDARD COLOURS

- White (WE) (Module)
- Stainless Steel (Flush Mount)

## Power Available Neon

The N01 Power Available Neon provides line supply power indication to groups of socket outlets mounted remotely from the RCD that they are protected by. This product is available as an individual item or can be incorporated within ESP Series medical service panels (MSPs).

### Features

- Amber in colour.
- Marked "POWER AVAILABLE".
- Fits all Clipsal size mechanism apertures.
- Supplied with Clipsal F30Z1.5 mounting clip.



N01

Catalogue No.	Description
N01	Power available neon

### Specifications

General	Description
Operational Voltage	240V a.c. 50Hz

## STANDARD COLOURS

- Amber (Neon)

### Line Isolation and Overload Monitor (LIOM)

The E05 Series Line Isolation and Overload Monitor (LIOM) in conjunction with the E14 Series Isolation Transformer form the basis of an isolated supply system, which provides electrocution and overload protection. The E05 Series LIOM is available in the ESP Series medical service panels (MSPs).

#### Features

- 5mA Prospective Hazard Current (PHC) alarm point.
- 1 to 9mA LCD Display.
- Visual PHC alarm, overload alarm, and alarm muted LED indication.
- Mutable two tone audible PHC and overload warning indication.
- Remote alarm contacts.
- In-built test facility.

#### Operation

An isolated supply is a continuous supply. The isolation transformer isolates the power from Earth, therefore a fault on both lines of secondary transformer winding to Earth needs to occur before a fault current flows. A fault on only one line and Earth will not cause a fault current to flow.

A LIOM enables the integrity of an isolated power supply system to be continuously monitored. The LIOM is able to detect when one fault occurs therefore is able to warn of a potential hazardous situation before any fault current actually flows. The first fault is known as Prospective Hazard Current (PHC). The LIOM displays the PHC on a LCD bargraph display and when 5mA PHC is reached a mutable alarm sounds along with a flashing LED indicator labelled "PHC Warning".

If a PHC alarm condition arises, the medical staff can, depending on the seriousness of the patient's condition, choose to continue with the procedure. In this situation, the surgeon is relying on a second fault not occurring that would turn the PHC into a real flow of current. During this time, measures can be taken to rectify the fault condition by, for example, disconnecting all non-essential equipment.

In addition to the LIOM monitoring isolation it also warns of an impending overload, thus averting problems which could result from a loss of supply. When the overload level is reached a mutable alarm sounds along with a "Overload Warning" flashing LED indicator.



**E05/36/1**

Catalogue No.	Description
E05/*/1	Surface Mount LIOM
E05/*/2	Flush Mount LIOM

#### Note:

- Replace "\*" within the catalogue number with either 36 (3.6kVA), 48 (4.8kVA) or 72 (7.2kVA) depending on the rating.
- If Flush Mounted the corresponding recessed wall box is catalogue number WB4.

### STANDARD COLOURS

■ Stainless Steel

# Line Isolation and Overload Monitor (LIOM)

## Specifications

General	Description
Operational Voltage	240V a.c. 50Hz
PHC Display	1 to 9mA LCD
PHC Alarm Point	5mA
Overload Alarm Point	15A (3.6kVA), 20A (4.8kVA), 30A (7.2kVA)
Audible Alarm	82 dB typical at 1 metre
Remote Alarm Contacts	Volt free, changeover, 5A relay contacts
Operating Temperature Range	10°C to 35°C
Dimensions	Surface Mount – 220mm(H) x 275mm(W) x 90mm(D) Flush Mount – 220mm(H) x 275mm(W) x 70mm(D)

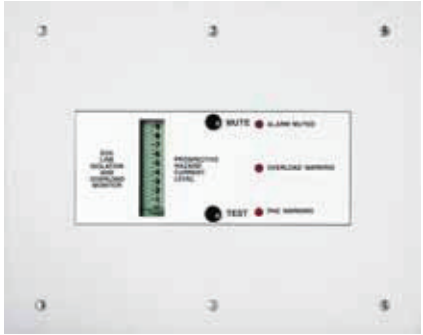

E05/36/2

## Wiring diagram

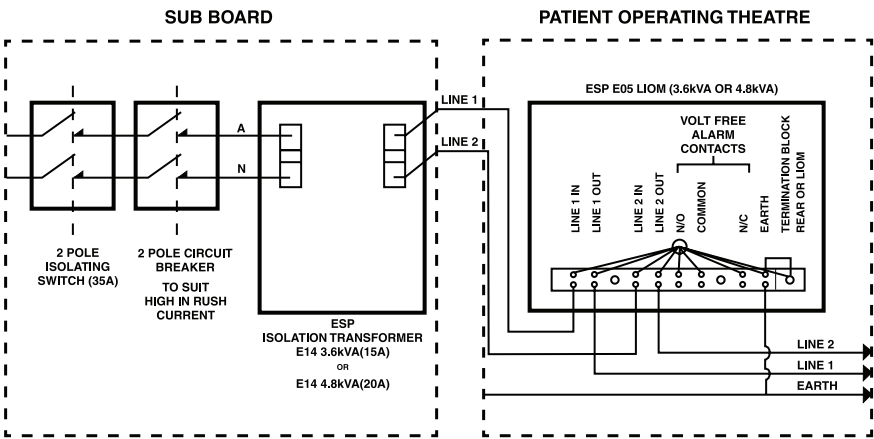

## STANDARD COLOURS

■ Stainless Steel

### E15T Series

The E15T Prospective Hazard Current (PHC) Simulator provides a convenient means for basic in-service testing of the line isolation monitor function of the E05 Line Isolation and Overload Monitor (LIOM). The tester incorporates a range of resistive and capacitive impedances that can be connected between each isolated line and Earth in various combinations.

#### Features

- Line 1 & 2 high standing PHC neon indicators.
- Line 1 & 2 capacitive PHC.
- Line 1 & 2 resistive PHC.

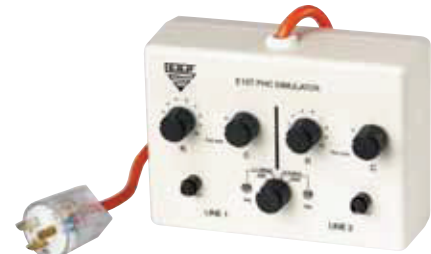

**E15T**

Catalogue No.	Description
E15T	LIM tester

#### Specifications

General	Description
Operational Voltage	240V a.c. 50Hz
Resistive PHC	1, 2, 3, 4, 5, 6, 7, 8, 9, 10mA +/-1% @ 240V a.c.
Capacitive PHC	1, 5, 10mA +/-5% @ 240V a.c.
Dimensions	135mm(H) x 185mm(W) x 90mm(D)

### STANDARD COLOURS

- White

## Isolation Transformer

The E14 Series Isolation Transformer in conjunction with the E05 Series Line Isolation and Overload Monitor form the basis of an isolated supply system, which provides electrocution and overload protection. This product is available in two different versions. E14/2 and E14/3 versions are economical while still meeting the requirements of the respective standards.

### Features

- Steel enclosure.
- The E14/2 version is fully encapsulated in heat-cured epoxy resin to reduce noise and prevent ingress of moisture and dust.

Catalogue No.	Description
E14/*/2	Encapsulated
E14/*/3	Non-encapsulated

### Note:

- Replace "\*" within the catalogue number with either 36 (3.6kVA) or 48 (4.8kVA) depending on the rating.

### Specifications

General	3.6kVA	4.8kVA	7.2kVA
Input Voltage	240V a.c. 50Hz		
Output Voltage	240V a.c. +/-2% 50Hz		
Regulation	+/-3%		
Current Rating	15A	20A	30A
No Load Current	1.0 amp max (0.5 amp typical)	2.0 amps max (1.0 amp typical) 2.0 amps max (1.0 amp typical)	
Max. Ambient Temperature	45°C (case may exceed 100°C on full load)		
<b>Weight (kg):</b>			
E14/*/2	35	40	52
E14/*/3	27	34	45
Dimensions (H x W x D)			
E14/*/2	210 x 300 x	210 x 300 x	260 x 300 x
E14/*/3	280mm	280mm	280mm
<b>Construction:</b>			
E14/*/2	Cased in steel enclosure and fully encapsulated in heat cured epoxy resin.		
E14/*/3	Cased in ventilated steel enclosure.		



E14/36/3



E14/46/3

## STANDARD COLOURS

- Blue (Steel)

### Isolation Transformer Specification Tables

E14/36/2	
Rating	3.6kVA
Type	Epoxy encapsulated
Duty Cycle	100%
Input	240VAC
Output	240VAC
Frequency	50/60Hz
Efficiency	96%
Watt Loss	<45W No Load
Total Losses	<120W Full Load
Voltage Regulation	3%
Noise Level	<17dbA
Insulation	Class H 180°C
Case Temperature	45°C at full load
Weight	40kg
Dimensions	300mm(W) x 300mm(H) x 235mm(D)

E14/48/2	
Rating	4.8kVA
Type	Epoxy encapsulated
Duty Cycle	100%
Input	240VAC
Output	240VAC
Frequency	50/60Hz
Efficiency	96%
Watt Loss	<60W No Load
Total Losses	<160W Full Load
Voltage Regulation	2.7%
Noise Level	<17dbA
Insulation	Class H 180°C
Case Temperature	45°C at full load
Weight	45kg
Dimensions	300mm(W) x 300mm(H) x 235mm(D)

## Isolation Transformer Specification Tables

<b>E14/36/3</b>	
Rating	3.6kVA
Type	Ventilated enclosure
Duty Cycle	100%
Input	240VAC
Output	240VAC
Frequency	50/60Hz
Efficiency	96%
Watt Loss	<45W No Load
Total Losses	<120W Full Load
Voltage Regulation	3%
Noise Level	<20dbA
Insulation	Class H 180°C
Case Temperature	45°C at full load
Weight	35kg
Dimensions	300mm(W) x 300mm(H) x 235mm(D)

<b>E14/48/3</b>	
Rating	4.8kVA
Type	Ventilated enclosure
Duty Cycle	100%
Input	240VAC
Output	240VAC
Frequency	50/60Hz
Efficiency	96%
Watt Loss	<60W No Load
Total Losses	<160W Full Load
Voltage Regulation	2.7%
Noise Level	<20dbA
Insulation	Class H 180°C
Case Temperature	45°C at full load
Weight	40k g
Dimensions	300mm(W) x 300mm(H) x 235mm(D)

### Equipotential Junction

The E35 Series Equipotential Junction form part of the equipotential Earthing System which provides micro electrocution protection in cardiac protected areas. The equipotential Earthing System requires all Earthed points within the cardiac protected area to be connected back to a common equipotential junction via low resistance Earth wiring (large cross section). The low resistance system reduces the potential difference between two Earthed points in the area, therefore reducing the risk of micro electrocution from the stray currents flowing in the Earthing System.

#### Features

- 1 x BP25 line tap for bus termination.
- 4 x 8mm and 10 x 5mm diameter termination tunnels (E35).
- 1 x equipotential stud for testing.
- Labelled "EQUIPOTENTIAL JUNCTION".



**E35/2**

Catalogue No.	Description
E35/2	Flush Mount equipotential junction

#### Note:

- If Flush Mounted the corresponding recessed wall box is catalogue number WB4.

#### Specifications

General	Description
Dimensions	Flush Mount - 220mm(H) x 275mm(W) x 70mm(D)

### STANDARD COLOURS

- Stainless Steel

## Equipotential Earth Stud

The R01 Equipotential Earth Stud provides a means to connect a piece of medical equipment to the equipotential Earthing System. This product is available as an individual item or can be incorporated within the three styles of ESP Series medical service panels (MSPs).

### Features

- Equipotential stud clearly identified in green.
- Screw clamping system for effective equipotential earthing connection.

Catalogue No.	Description
R01	Equipotential Earth Stud
POAG-1D6	Recessed Equipotential Earth stud



R01



POAG-1D6

## STANDARD COLOURS

 Green (Stud)

### Socket Outlets and Modules - M-Style

This product is available as an individual module or incorporated within ESP Series medical service panels (MSPs).

#### Features

- Moulded in chemically resistant Valox.
- Double pole switching.
- Safety shutters.
- Red 'switched power' neon.
- 10A or 15A.
- Modular DIN rail mounted design.

Catalogue No.	Description
E015VDN	Socket outlet module 10A
E015VDN15	Socket outlet module 15A
MLHG02M2	2 Socket outlet module 10A, including fascia for flush-mounting
MLHG04M2	4 Socket outlet module 10A, including fascia for flush-mounting
MLHG06M2	2 Socket outlet module 10A, including fascia for flush-mounting
MLHG08M2	2 Socket outlet module 10A, including fascia for flush-mounting
MLHG02M2-N	Flush Mount – 2 outlet, with neon "Power available"
MLHG04M2-N	Flush Mount – 4 outlet, with neon "Power available"
MLHG06M2-N	Flush Mount – 6 outlet, with neon "Power available"
MLHG08M2-N	Flush Mount – 8 outlet, with neon "Power available"

#### Note:

- If the switched sockets are powered from a remotely mounted RCD then an amber power available neon will need to be added to the MSP.
- The corresponding recessed wall box is catalogue number WB2 (2 outlets), WB4 (4 outlets), WB6 (6 outlets) and WB8 (8 outlets).

#### Specifications

General	Description
Operational Voltage	240V a.c. 50Hz
Max. Load	10 or 15A (standard MSP fitted with 10A)
Spacing	MSP outlets spaced 45mm between centres
Dimensions	Socket outlet – 74mm(H) x 45mm(W) Flush Mount module (fascia and socket outlets) (2 outlet) – 220mm(H) x 175mm(W) x 70mm(D) (4 outlet) – 220mm(H) x 275mm(W) x 70mm(D) (6 outlet) – 220mm(H) x 425mm(W) x 70mm(D) (8 outlet) – 220mm(H) x 525mm(W) x 70mm(D)

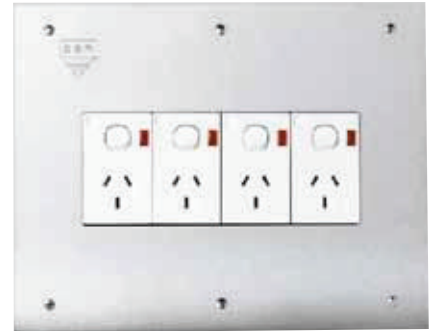

MLHG04M2

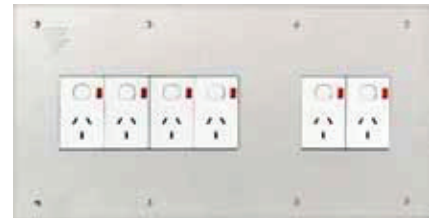

MLHG04M2-N

### STANDARD COLOURS

- Stainless Steel (Flush Mount)
- White (WE) (Socket Outlet)
- Red (RD) (Socket Outlet)
- Dark Blue (DB) (Socket Outlet)

## Socket Outlets and Modules - O-Style

This product is available as an individual item or incorporated within three different styles of ESP Series medical service panels (MSPs).

### Features

- Double or single pole switching.
- Safety shutters.
- Optional red 'switched power' neon.
- Vertical or horizontal configuration.
- 10A or 15A.

Catalogue No.	Description
ML/ABC15VDNM	Socket outlet, vertical, double pole, neon, 10A
ML/ABC15VDM	Socket outlet, vertical, double pole, 10A
ML/ABC15VNM	Socket outlet, vertical, neon, 10A
ML/ABC15VM	Socket outlet, vertical, 10A
ML/ABC15DNM	Socket outlet, horizontal, double pole, neon, 10A
ML/ABC15DM	Socket outlet, horizontal, double pole, 10A
ML/ABC15NM	Socket outlet, horizontal, neon, 10A
ML/ABC15M	Socket outlet, horizontal, 10A
MLHG0202	Flush Mount – 2 outlet (includes fascia)
MLHG0402	Flush Mount – 4 outlet (includes fascia)
MLHG0602	Flush Mount – 6 outlet (includes fascia)
MLHG0802	Flush Mount – 8 outlet (includes fascia)
MLHG0202-N	Flush Mount – 2 outlet C/W PA neon (includes fascia)
MLHG0402-N	Flush Mount – 4 outlet C/W PA neon (includes fascia)
MLHG0602-N	Flush Mount – 6 outlet C/W PA neon (includes fascia)
MLHG0802-N	Flush Mount – 8 outlet C/W PA neon (includes fascia)

### Note:

- If the switched sockets are powered from a remotely mounted RCD then an amber power available neon will need to be added to the MSP.
- If Flush Mounted then the corresponding recessed wall box is catalogue number WB2 (2 outlets), WB4 (4 outlets), WB6 (6 outlets) and WB8 (8 outlets).

### Specifications

General	Description
Operational Voltage	240V a.c. 50Hz
Max Load	10 or 15A (standard MSP fitted with 10A)
Spacing	MSP outlets spaced 45mm between centres
Dimensions	Socket outlet – 74mm(H) x 45mm(W) Flush Mount module (fascia and socket outlets) (2 outlet) – 220mm(H) x 175mm(W) x 70mm(D) (4 outlet) – 220mm(H) x 275mm(W) x 70mm(D) (6 outlet) – 220mm(H) x 425mm(W) x 70mm(D) (8 outlet) – 220mm(H) x 525mm(W) x 70mm(D)



ML/ABC15VDNM



MLHG0402



MLHG0602

## STANDARD COLOURS

- Stainless Steel (Flush Mount)
- White (WE) (Socket Outlet)
- Red (RD) (Socket Outlet)
- Dark Blue (DB) (Socket Outlet)

### RCD Relay

The E03 Series RCD Relay, when combined with a shunt trip circuit breaker, provides electrocution protection.

The RCD relay, combined with a shunt trip circuit breaker, is typically used for high load current or three phase applications, such as protecting x-ray machines.

#### Features

- 10mA trip current.
- Suitable for single to three phase applications.
- Amber load supply indicator.
- In-built test facility.

Catalogue No.	Description
E03/10/10	RCD Relay 10mA 10ms
E03/30/10	RCD Relay 30mA 10ms

#### Note:

- In 3-phase applications without neutral, a transformer is required to be installed.



E03/10/10

#### Specifications

General	Description
Trip Current	10mA or 30mA
Trip Time	< 10ms
Operational Voltage	240V a.c. 50Hz
Operating Temperature Range	-10°C to +55°C
Load Range (shunt trip coil)	50 – 250Ω ohms
Dimensions	141mm(H) x 27mm(W) x 72mm(D)
Hole Dimension	ø32mm

#### Wiring diagram

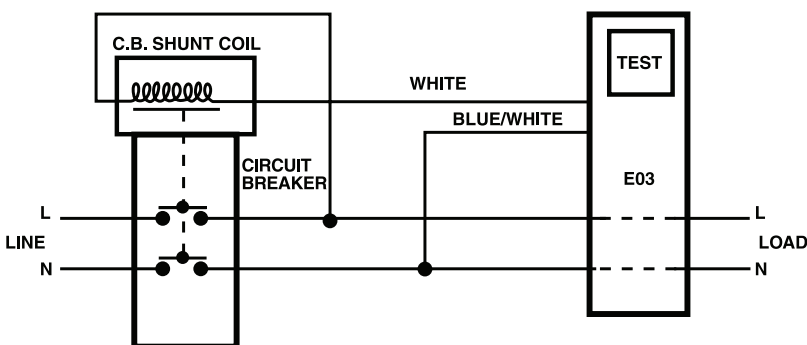

#### STANDARD COLOURS

- Electric Orange (EO)

# ESP

## Portable RCD/MCB Protected Power Outlets

The E12 and E13 are portable RCD/MCB protected power outlets that provide electrocution and overload protection. This product is used to temporarily upgrade an unprotected area into a body protected area.

### Features

- 10mA trip current.
- Overload protection.
- Amber power available neon.
- 2 (E12) or 4 (E13) outlets.
- 3 metre power cord.
- In-built indicator to indicate whether an RCD or MCB fault has occurred.
- In-built test facility.

Catalogue No.	Description
E12	Portable RCD/MCB – 2 outlet
E13	Portable RCD/MCB – 4 outlet

### Specifications

General	Description
Number of Outlets	2 (E12) or 4 (E13)
Trip Current	10mA
Trip Time	< 40ms
Operational Voltage	240V a.c. 50Hz
Current Rating	10A (15A optional)
Operating Temperature Range	-10°C to +55°C
Mains Cord	3 metres
Dimensions	160mm(H) x 130mm(W) x 120mm(D)



E12



E13

## STANDARD COLOURS

- Electric Orange (EO)

### Audible/Visual Alarm

The E08 Series Audible Alarm is used in conjunction with the E38 Series Combination RCD Relay/Circuit Breaker or E03 Series RCD Relay. It is used to provide audible and visual indication of when the RCD it is monitoring trips.

#### Features

- Multiple two tone audible indication.
- Red visual alarm indicator.
- Mute push-button marked "PRESS TO MUTE".
- Optional remote alarm contacts.



E08

Catalogue No.	Description
E08	Audible alarm module

#### Specifications

General	Description
Operational Voltage	240V a.c. 50Hz
Audible Alarm	64 dB typical at 1 metre
Remote Alarm Contacts (optional)	Volt free, changeover, 5A/240V relay contacts
Dimensions	141mm(H) x 27mm(W) x 72mm(D)

#### Wiring diagram

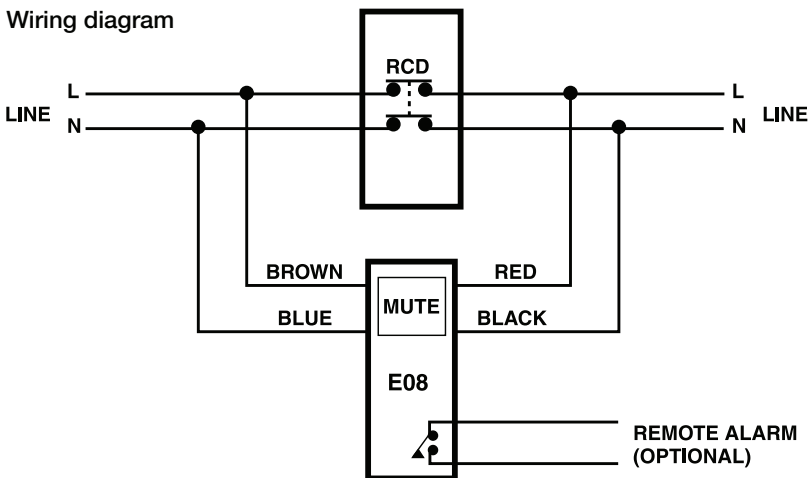

### STANDARD COLOURS

- Electric Orange (EO)

# ESP

## Area Classification Signs

The SIGN/BPA and SIGN/CPA Area Classification Signs provide indication as to the area classification, either body or cardiac protected.

### Features

- Clearly identifiable in green.
- Made from sturdy laminex.
- Adhesive on each corner for easy installation.
- Supplied with “test and date” stickers.

Catalogue No.	Description
SIGN/BPA	Body area sign
SIGN/CPA	Cardiac area sign

### Specifications

General	Description
Dimensions	90mm(H) x 200mm(W)



SIGN/BPA



SIGN/CPA

## STANDARD COLOURS

 Green

Catalogue No.	Page	Catalogue No.	Page	Catalogue No.	Page
154	21	E08	68	ML2164	29
157	21	E08M	54	ML2164/1F	33
2000	20	E12	67	ML2164/1F	47
2015	19	E13	67	ML2164/1FC2	33
2025	19	E14/*/2	59	ML2164/1FC2	47
5900900	41	E14/*/3	59	ML2164/1FE2	33
155P	21	E15T	58	ML2164/1FE2	47
2000/2	20	E35/2	62	ML2164/1G	31
2000/3	20	ESP	50	ML2164/1G	46
2000/4	20	LAPLT70G	41	ML2164/1W	30
2000H2	20	ML/ABC15DM	65	ML2164/2F	33
2000H3	20	ML/ABC15DNM	65	ML2164/2F	47
2015V	19	ML/ABC15M	65	ML2164/2FC2	33
2025V	19	ML/ABC15NM	65	ML2164/2FC2	47
2031HA	19	ML/ABC15VDM	65	ML2164/2FE2	33
2031VA	19	ML/ABC15VDNM	65	ML2164/2FE2	47
2031VRJ	19	ML/ABC15VM	65	ML2164/2G	31
2031VTO	19	ML/ABC15VNM	65	ML2164/2G	46
2032E450UD	19	ML2000	9	ML2164/2W	30
2032HA	19	ML2015	13	ML2164/3F	33
2032VA	19	ML2015/15C	14	ML2164/3F	47
2032VRJ	19	ML2015/15I	13	ML2164/3FC2	33
2033HA	19	ML2015/15VI	12	ML2164/3FC2	47
2033VA	19	ML2015C	14	ML2164/3FE2	33
2034HA	19	ML2015D	13	ML2164/3FE2	47
2034VA	19	ML2015I	13	ML2164/3G	31
2035VA	19	ML2015IC	14	ML2164/3G	46
2036VA	19	ML2015V	12	ML2164/3W	30
2154/2	21	ML2015VD	12	ML2164/4F	33
2154/3	21	ML2015VDI	12	ML2164/4F	47
2154/4	21	ML2015VI	12	ML2164/4G	31
2154H2	21	ML2025	13	ML2164/4G	46
2154H3	21	ML2025C	14	ML2164/4W	30
2155PHRM2	21	ML2025I	13	ML2164E35	32
2155PHRM3	21	ML2025RC10	16	ML2164E35	48
2155PRM2	21	ML2025RC10C	16	ML2164E35F	33
2155PRM3	21	ML2025V	12	ML2164E35F	47
2155PRM4	21	ML2025VI	12	ML2164FMB	34
2157/2	21	ML2031E08	11	ML2164GMB	34
2157/3	21	ML2031EU	18	ML2164JP	34
2157/4	21	ML2031R01	17	ML2164JP2	34
2157H2	21	ML2031RC10	10	ML2164JT	34
2157H3	21	ML2031VE08	11	ML2164S	34
E01/*/2	53	ML2031VR01	17	ML2165	23
E015VDN	64	ML2031VRC10	10	ML2165SS-1C	25
E015VDN15	64	ML2032R02	17	ML2165SS-1E	25
E01CNN*	53	ML2032VR02	17	ML2165SS-1P	24
E02/*/2	54	ML2144	45	ML2165SS-2C	25
E03/10/10	66	ML2144/1	46	ML2165SS-2E	25
E03/30/10	66	ML2144/2	46	ML2165SS-2P	24
E05/*/1	56	ML2144/3	46	ML2165SS-3C	25
E05/*/2	56	ML2144/4	46	ML2165SS-3E	25

Catalogue No.	Page
ML2165SS-3P	24
ML2165SS-4C	25
ML2165SS-4E	25
ML2165SS-4P	24
ML2165SS-EPJ	26
ML25S	15
MLH921	37
MLH921-1C	40
MLH921-1E	40
MLH921-1P	38
MLH921-2C	40
MLH921-2E	40
MLH921-2P	38
MLH921-3C	40
MLH921-3E	40
MLH921-3P	38
MLH921-4C	40
MLH921-4E	40
MLH921-4P	38
MLH921BE	41
MLH921D	41
MLH921EP	41
MLH921-EPJ	39
MLH921L	41
MLH921SP	41
MLHG02M2	64
MLHG02M2-N	64
MLHG02O2	65
MLHG02O2-N	65
MLHG04M2	64
MLHG04M2-N	64
MLHG04O2	65
MLHG04O2-N	65
MLHG06M2	64
MLHG06M2-N	64
MLHG06O2	65
MLHG06O2-N	65
MLHG08M2	64
MLHG08M2-N	64
MLHG08O2	65
MLHG08O2-N	65
N01	55
POAG-1D6	63
R01	63
SIGN/BPA	69
SIGN/CPA	69
WB2	52
WB4	52
WB6	52
WB8	52

---

**Schneider Electric (Australia) Pty Ltd**

33-37 Port Wakefield Road, Gepps Cross,  
South Australia 5094

PO Box 132, Enfield Plaza,  
South Australia 5085

Telephone: (08) 8161 0511  
Facsimile: (08) 8161 0900  
Email: [plugin@clipsal.com.au](mailto:plugin@clipsal.com.au)  
Internet: [www.clipsal.com](http://www.clipsal.com)

**National Customer Care Enquiries:  
1300 2025 25**

**National Customer Care Facsimile:  
1300 2025 56**

**International Enquiries  
International Sales and Marketing**

Email: [export@clipsal.com.au](mailto:export@clipsal.com.au)

**Schneider Electric (NZ) Ltd**

38 Business Parade South, Highbrook,  
East Tamaki, Manukau 2013,  
NEW ZEALAND

Telephone: + 64 9 829 0490  
Facsimile: + 64 9 829 0491  
Internet: [www.schneider-electric.co.nz](http://www.schneider-electric.co.nz)

**Customer Care**

Freephone: 0800 652 999  
Freefax: 0800 101 152  
Email: [sales@nz.schneider-electric.com](mailto:sales@nz.schneider-electric.com)  
Internet: [www.clipsal.co.nz](http://www.clipsal.co.nz)

You can find this brochure and many others  
online in PDF format at: [clipsal.com](http://clipsal.com)

Follow the links off the home page or access  
the following page directly:  
[clipsal.com/brochures](http://clipsal.com/brochures)

**[clipsal.com](http://clipsal.com)**

Schneider Electric (Australia) Pty Ltd reserves the right  
to change specifications, modify designs and discontinue  
items without incurring obligation and whilst every effort is  
made to ensure that descriptions, specifications and other  
information in this catalogue are correct, no warranty is  
given in respect thereof and the company shall not be liable  
for any error therein.

© 2012 Schneider Electric. All Rights Reserved.

Trademarks are owned by Schneider Electric Industries  
SAS or its affiliated companies.

This document has been printed using FSC Mix Certified paper.  
ISO 14001 environmental management system in use at mill.