

HARDWARE
Nuts and bolts

Print Recommend this page

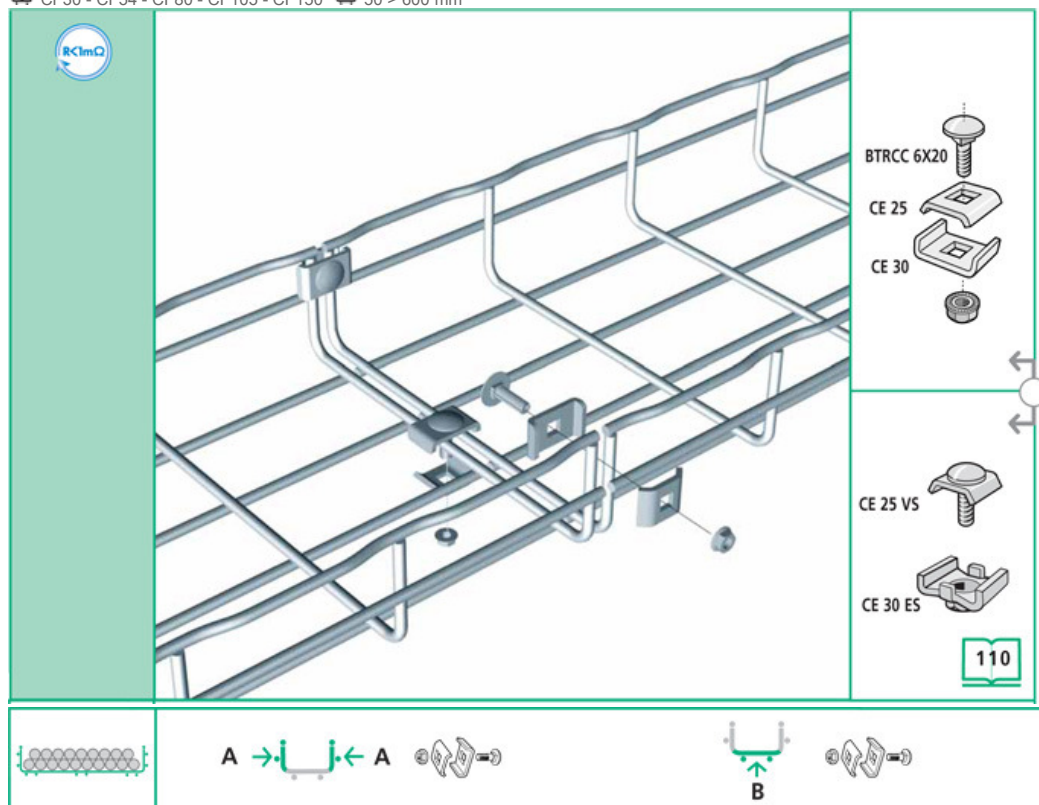





CE 25 - CE 30







CF30 - CF54 - CF80 - CF105 - CF150 50 > 600 mm



	50		100		150		200		300		400>450		500		600	
	A	B	A	B	A	B	A	B	A	B	A	B	A	B	A	B
CF30 - CF54	2	0	2	1	2	1	2	1	2	2	2	2	2	2	2	3
CF80			2	1			2	1	2	2	2	2	2	3	2	3
CF105			2	1	2	1	2	1	2	2	2	3	2	3	2	3
CF150							2	2	2	2	2	3	2	3	2	3
HDF105	2	1	2	1	2	1	2	1	2	2	2	3	2	3	2	3

CFG - CFC			2	1	2	1	2	1								
-----------	--	--	---	---	---	---	---	---	--	--	--	--	--	--	--	--

CE 25 - CE 30 - BTRCC 	CE25 CE30 BTRCC 6x20 KITASSTR = CE25+CE30+BTRCC	 50 50 100 50	 558 011 558 041 801 011 558 081	 558 013 558 043 801 017 558 087	 558 018 558 048 801 018 -	 558 014 558 044 801 014 -

CE 25 VS - CE 30 ES 	CE 25 VD CE 30 ES KITASSVS = CE25VS+CE30ES	 50 50 50	 558 021 558 031 558 071	 558 027 558 037 558 077	 - - -	 - - -

CE 25 VS - CE 30 - EEC6 	KITINOX	 50	 -	 -	 -	 558 954

Source URL: <http://www.cablofil.com.au/product/nuts-and-bolts/ce-25-ce-30>