



Dialight® LED Reliant™ High Bay

Technical Specification Sheet - APAC

Reliant™ LED High Bay 100-277 VAC



Certifications & Ratings

- 10 year warranty
- CE
- RCM*
- IP66
- L70 rated for >100,000 hours @ 55°C
- L90 rated for >100,000 hours @ 25°C

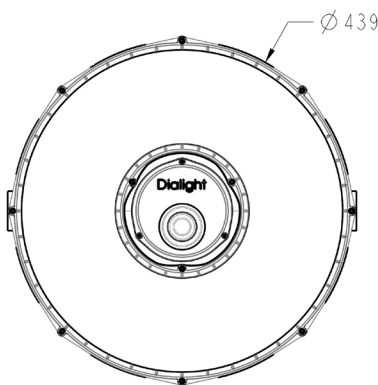
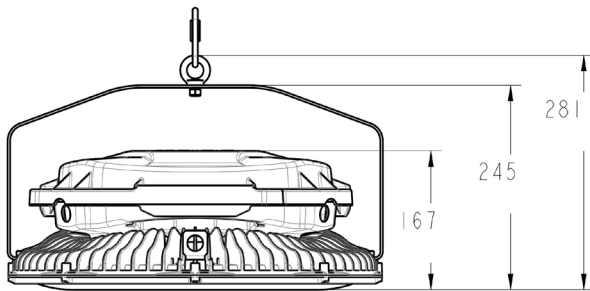

Dimensions in mm

Mechanical Information:

Fixture weight:	9.3 kg
Shipping weight:	12 kg
Box dimensions:	515 x 515 x 350mm

Mounting:

Mounting:	304 stainless steel mounting bracket
-----------	--------------------------------------

Electrical Specifications:

Operating voltage:	100-277 VAC 50/60Hz
Operating temperature:	-40°C to +55°C
Total system power consumption:	See ordering table
EMC:	EN 55015 IEC 61000-3-3 IEC 61547 IEC 61000-4-2 IEC 61000-4-3 IEC 61000-4-6 IEC 61000-4-8 IEC 61000-4-11
Transient protection:	6kV/3kA combination wave, as per IEEE C62.41, line-line and line-ground IEC 61000-4-5 IEC 61000-4-4
THD:	IEC 55015 <20% @ 100-277 VAC
Harmonics:	IEC 61000-3-2, Class C
Power factor:	>0.9 @ 100-277 VAC
Flicker:	IEC 61000-3-3
Dimming:	DALI 1.0 and 2.0 5% 0-10 VDC continuous dimming to 5% Wireless dimming via Dialight IntelliLED controls to 5%
Cable entry:	(3) M20 1.8m cable & plug (Australia only)
Terminals:	5 position, 0.5-4 mm ²
Materials:	
Housing:	Polycarbonate (upper) Aluminium (lower)
Lens:	Acrylic Polycarbonate & glass options available
Hardware:	304 stainless steel
Hook:	304 stainless steel
Fixture finish:	Superior dual coat finish - sealed polyester topcoat - epoxy primer

Gaskets:

Light engine:	Santoprene
Wiring box:	EPDM

Photometric Information:

CRI:	80
CCT:	4000K (neutral white) 5000K (cool white)

All values typical unless otherwise stated (tolerance +/- 10%)
*Values based on preliminary data awaiting validation or certification.

WARNING - INSTALLATION & SECONDARY RETENTION. Use of any Dialight products without proper installation (including secondary retention / netting) and periodic inspections could cause severe injury or death. Dialight recommends that all installations should use secondary retention / netting (appropriate to the installation environment) where applicable. It is the exclusive responsibility of the contractor, installer and/or end-user to: (a) determine the suitability of the product for its intended application; and, (b) ensure that the product is safely installed (with secondary retention / netting where appropriate) and in compliance with all applicable laws and regulations. To the extent permissible under applicable laws, Dialight disclaims all liability for personal injury and/or other damage resulting from any dislodgment or other dislocation of its products.

Ordering Information

Reliant™ LED High Bay - 100-277 VAC



Australia

Part Number	Fixture Lumen	Wattage	lm/W	CCT	Lens	Beam Distribution	Mounting
DALI Models							
RRE-2MN2-ADH1-AGN	11,100	71	156	4000K (neutral white)	Acrylic	Medium	Hook, 1.8m cable & plug
RRE-2MN2-BDH1-AGN	14,000	91	154	4000K (neutral white)	Acrylic	Medium	Hook, 1.8m cable & plug
RRE-2MN2-CDH1-AGN	17,600	114	154	4000K (neutral white)	Acrylic	Medium	Hook, 1.8m cable & plug
RRE-2MN2-EDH1-AGN	23,800	159	150	4000K (neutral white)	Acrylic	Medium	Hook, 1.8m cable & plug
RRE-2MN2-GDH1-AGN	29,400	191	154	4000K (neutral white)	Acrylic	Medium	Hook, 1.8m cable & plug
RRE-2MN2-JDH1-AGN	35,300	232	152	4000K (neutral white)	Acrylic	Medium	Hook, 1.8m cable & plug

All values typical unless otherwise stated (tolerance +/- 10%).
For additional controls options including occupancy sensor and IntelliLED wireless controls, contact a Dialight sales representative.

Asia

Part Number	Fixture Lumen	Wattage	lm/W	CCT	Lens	Beam Distribution	Mounting
DALI Models							
RRE-2MC2-ADHN-NGN	11,300	71	159	5000K (cool white)	Acrylic	Medium	Hook
RRE-2MC2-BDHN-NGN	14,300	91	157	5000K (cool white)	Acrylic	Medium	Hook
RRE-2MC2-CDHN-NGN	18,000	114	158	5000K (cool white)	Acrylic	Medium	Hook
RRE-2MC2-EDHN-NGN	24,300	159	153	5000K (cool white)	Acrylic	Medium	Hook
RRE-2MC2-GDHN-NGN	30,000	191	157	5000K (cool white)	Acrylic	Medium	Hook
RRE-2MC2-JDHN-NGN	36,000	232	155	5000K (cool white)	Acrylic	Medium	Hook

All values typical unless otherwise stated (tolerance +/- 10%).
For additional controls options including occupancy sensor and IntelliLED wireless controls, contact a Dialight sales representative or see spec sheet.

Australia & Asia Accessories

Part Number	Description
HBXCAB48	1.2m long stainless steel safety rope (for use with safety bracket)
RR-WIRELESS-1	IntelliLED wireless controls - basic
RR-WS-OCC-212	Wattstopper FSP 212 (center mounted) occupancy and daylight harvesting sensor

Accessories



HBXCAB48



RR-WIRELESS-1



RR-WS-OCC-212

DISCLAIMER. All product information provided is, to the best of Dialight's knowledge, accurate as of the date of publication. When ordering, refer to www.dialight.com for current versions of: (a) relevant product documentation (including the relevant product data sheets); (b) Dialight terms and conditions of sale; and, (c) the relevant product warranty. To the extent that any contract is deemed formed between Dialight and the purchaser of Dialight products and/or an end-user, versions of documents available at www.dialight.com as at the date of sale shall be the versions incorporated therein. In the event of any discrepancy between this document or information provided at www.dialight.com, the latter shall prevail.

Beam Distribution

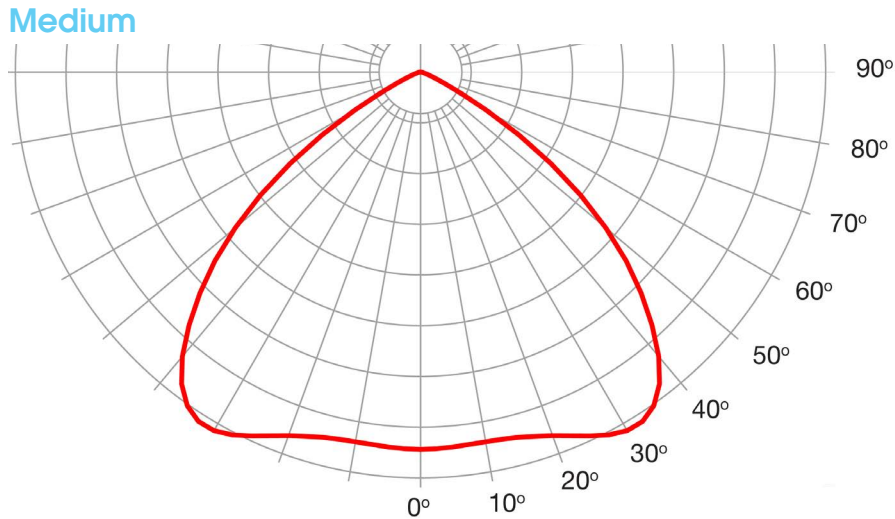

Inrush Current / Circuit Breakers

Wattage	Inrush current @ input voltage			Approximate time duration (T50) of inrush current			Maximum number of lights per breaker (@230VAC)	
	120 VAC	230 VAC	277 VAC	100 VAC	230 VAC	277 VAC	10 Amp	16 Amp
232	8A	15A	18A	1.5ms	1.5ms	1.5ms	6	9
191	8A	15A	18A	1.5ms	1.5ms	1.5ms	7	12
159	8A	15A	18A	1.5ms	1.5ms	1.5ms	9	14
114	8A	15A	18A	1.5ms	1.5ms	1.5ms	12	20
91	8A	15A	18A	1.5ms	1.5ms	1.5ms	19	31
71	8A	15A	18A	1.5ms	1.5ms	1.5ms	20	33

DISCLAIMER. All product information provided is, to the best of Dialight's knowledge, accurate as of the date of publication. When ordering, refer to www.dialight.com for current versions of: (a) relevant product documentation (including the relevant product data sheets); (b) Dialight terms and conditions of sale; and, (c) the relevant product warranty. To the extent that any contract is deemed formed between Dialight and the purchaser of Dialight products and/or an end-user, versions of documents available at www.dialight.com as at the date of sale shall be the versions incorporated therein. In the event of any discrepancy between this document or information provided at www.dialight.com, the latter shall prevail.

Lumen Maintenance Factor

Reliant High Bay 11,000-30,000lm (Hours)										
Ambient Celsius	Ambient	0	15000	30000	45000	60000	75000	90000	100000	150000
25	100%	98%	96%	95%	94%	92%	91%	90%	89%	86%
30	100%	97%	96%	95%	93%	92%	91%	90%	89%	86%
35	99%	97%	95%	94%	93%	92%	90%	89%	88%	85%
40	98%	96%	95%	93%	92%	91%	90%	89%	88%	85%
45	98%	96%	94%	93%	92%	90%	89%	88%	87%	84%
50	94%	92%	91%	89%	88%	87%	86%	85%	84%	81%
55	94%	85%	84%	83%	81%	80%	79%	78%	77%	74%

Reliant High Bay 36,000lm (Hours)										
Ambient Celsius	Ambient	0	15000	30000	45000	60000	75000	90000	100000	150000
25	100%	98%	96%	95%	94%	92%	91%	90%	89%	86%
30	99%	97%	96%	94%	93%	92%	90%	89%	88%	85%
35	99%	96%	95%	94%	92%	91%	90%	89%	88%	85%
40	98%	96%	95%	93%	92%	91%	90%	89%	88%	85%
45	91%	89%	88%	87%	85%	84%	83%	82%	81%	78%
50	85%	83%	81%	80%	79%	78%	77%	76%	75%	73%
55	85%	74%	72%	71%	70%	69%	68%	67%	66%	64%

Thermal Roll-Off

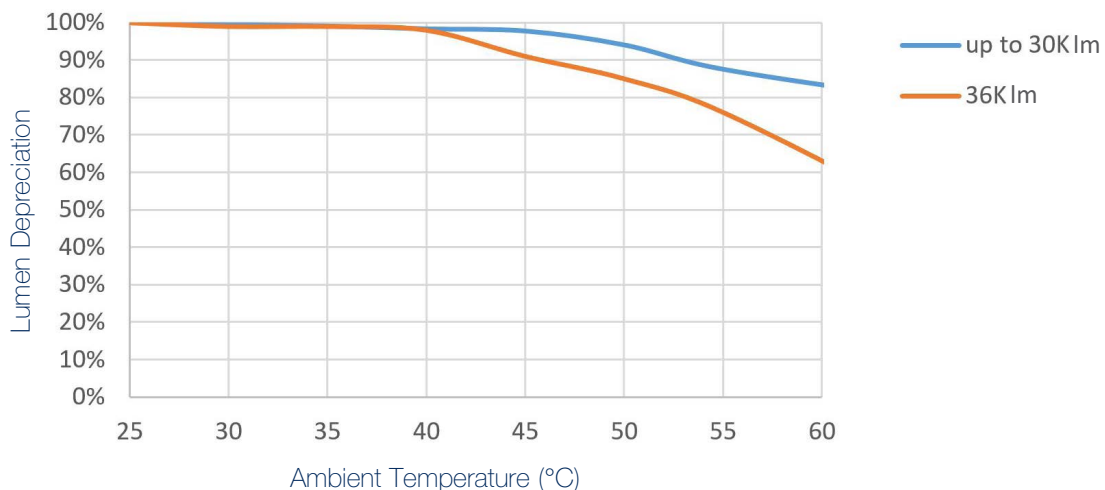

DISCLAIMER. All product information provided is, to the best of Dialight's knowledge, accurate as of the date of publication. When ordering, refer to www.dialight.com for current versions of: (a) relevant product documentation (including the relevant product data sheets); (b) Dialight terms and conditions of sale; and, (c) the relevant product warranty. To the extent that any contract is deemed formed between Dialight and the purchaser of Dialight products and/or an end-user, versions of documents available at www.dialight.com as at the date of sale shall be the versions incorporated therein. In the event of any discrepancy between this document or information provided at www.dialight.com, the latter shall prevail.

Dimming Characteristics

DALI Dimming

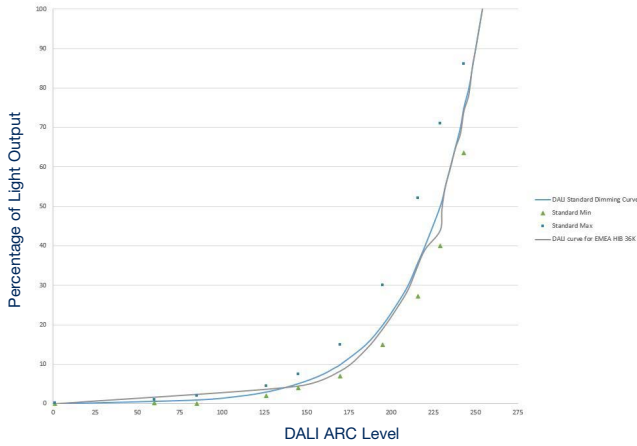

IntelliLED Dimming

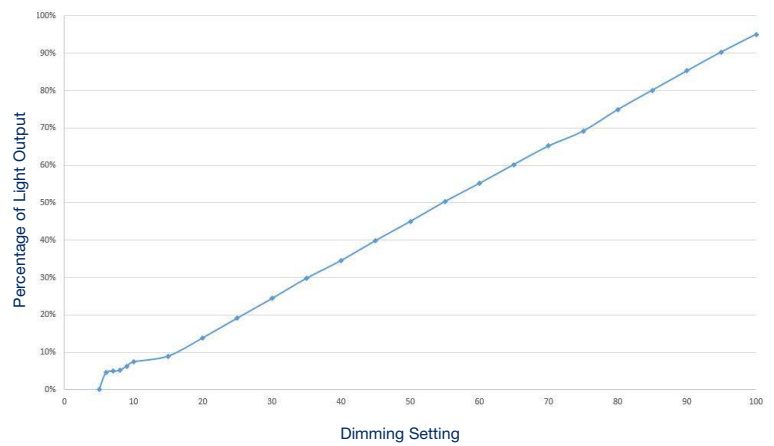

0-10V Dimming

Input Power VS Dimming Voltage

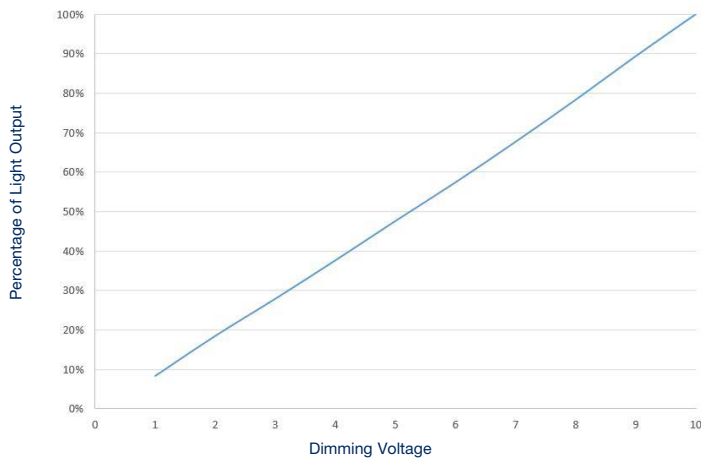

Light Output VS Dimming Voltage

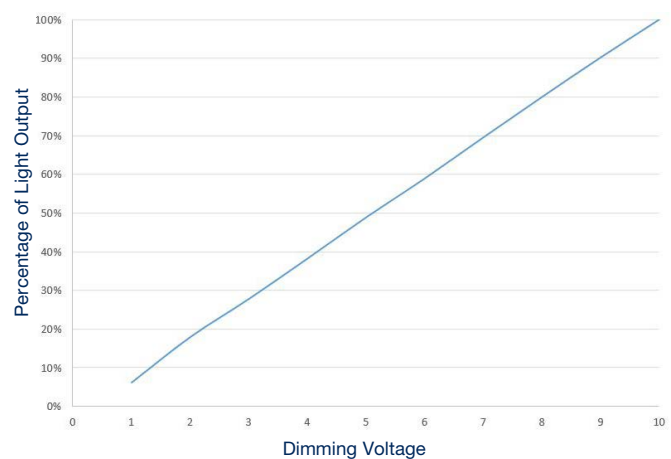

DISCLAIMER. All product information provided is, to the best of Dialight's knowledge, accurate as of the date of publication. When ordering, refer to www.dialight.com for current versions of: (a) relevant product documentation (including the relevant product data sheets); (b) Dialight terms and conditions of sale; and, (c) the relevant product warranty. To the extent that any contract is deemed formed between Dialight and the purchaser of Dialight products and/or an end-user, versions of documents available at www.dialight.com as at the date of sale shall be the versions incorporated therein. In the event of any discrepancy between this document or information provided at www.dialight.com, the latter shall prevail.

Occupancy Sensor Details

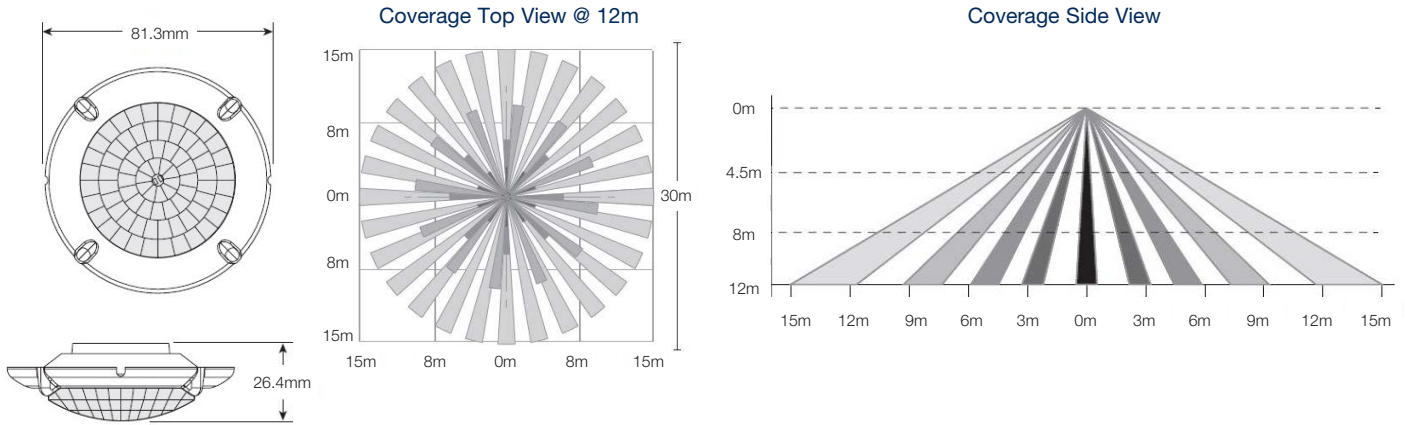

Accessories



HBXCAB48

- 1.2m long stainless steel safety rope (for use with safety bracket)



RR-WIRELESS-1

- IntelliLED wireless control



RR-WS-OCC-212

- Wattstopper FSP 212 (center mounted) occupancy and daylight harvesting sensor

DISCLAIMER. All product information provided is, to the best of Dialight's knowledge, accurate as of the date of publication. When ordering, refer to www.dialight.com for current versions of: (a) relevant product documentation (including the relevant product data sheets); (b) Dialight terms and conditions of sale; and, (c) the relevant product warranty. To the extent that any contract is deemed formed between Dialight and the purchaser of Dialight products and/or an end-user, versions of documents available at www.dialight.com as at the date of sale shall be the versions incorporated therein. In the event of any discrepancy between this document or information provided at www.dialight.com, the latter shall prevail.

Australia

108 Howe Street
Osborne Park, WA 6017
Tel: +61 (0) 8 9244 7600
Fax: +61 (0) 8 9244 7601
info@dialight.com.au

Southeast Asia

33 Ubi Avenue 3
#07-72 Vertex (Tower A)
Singapore 408868
Tel: +65 6578 7157
Fax: +65 6578 7150
enquiry@dialight.com.sg

WARNING / DISCLAIMERS:

Installation & secondary retention. The use of this product without proper installation (including secondary retention / netting) and periodic inspections, could cause severe injury or death. Dialight recommends that all installations should use secondary retention / netting (appropriate to the installation environment) as applicable. Dialight products are intended for ultimate purchase, installation and operation by knowledgeable persons trained in the functional assessment, installation, use and maintenance of such products and all customers (including but not limited to end customers) are responsible for assessing the suitability of Dialight products for any given installation requirement. It is the exclusive responsibility of the contractor, installer and/or end-user to: (a) determine the suitability of the product for its intended application; and, (b) ensure that the product is safely installed (with secondary retention / netting as appropriate) and in compliance with all applicable laws and regulations.

Product specifications & warranties. All product information provided is, to the best of Dialight's knowledge, accurate as of the date of publication. All values and performance data herein are design or typical values when measured under laboratory conditions. The information herein is subject to change without notice. The products / software detailed herein are subject to applicable warranties and terms and conditions of use/purchase. Unless agreed otherwise in writing by an authorized representative of Dialight, Dialight does not represent that its products are fit for any particular purpose and accepts no liability for the installation and/or unauthorised use of its products. When ordering, refer to www.dialight.com for current versions of: (a) relevant product documentation (including relevant product data sheets); (b) Dialight terms and conditions of sale; and, (c) the relevant product warranties. To the extent that any contract is deemed formed between Dialight and the purchaser of Dialight products and/or an end-user, versions of documents available at www.dialight.com as at the date of sale shall be the versions incorporated therein. In the event of any discrepancy between this document and information provided at www.dialight.com, the latter shall prevail.

Exclusion of liability. To the extent permissible under the relevant law, Dialight disclaims all liability for personal injury and/or other damage resulting from any dislodgment or other dislocation of its products. Whilst Dialight has used its reasonable endeavours to ensure the completeness and accuracy of information herein, Dialight does not assume any liability for damages resulting from use of this information or for any third-party representations made in relation to Dialight products.